



website: <http://www.lgservice.com>
e-mail: <http://www.lgservice.com/techsup.html>

GR-349R/RP GR-389R/RP

REFRIGERATOR- FREEZER

User's Guide (2~16)

Please read this User's Guide carefully before operating and keep it handy for reference at all times.

REFRIGERATEUR- CONGELATEUR

Manuel de l'utilisateur (18~32)

Lisez avec attention ce Manuel de l'utilisateur avant d'utiliser le réfrigérateur et gardez-le toujours pour toute référence.

FRIGORIFICO- CONGELADOR

Instrucciones de uso (34~48)

Lea estas instrucciones de uso con atención antes de poner el aparato en funcionamiento y manténgalo siempre a mano para que pueda consultarlo en cualquier momento.

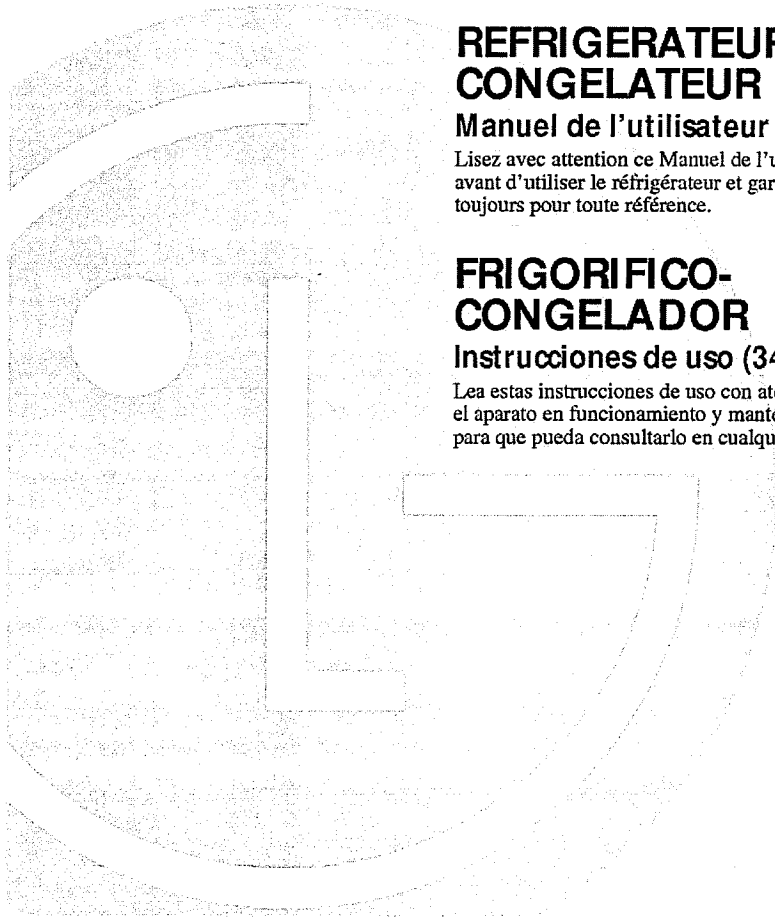

TABLE OF CONTENTS

REFRIGERATOR SAFETY 3

INSTALLING YOUR REFRIGERATOR 4

 Unpacking Your Refrigerator 4

 Installation 4

 Electrical Requirements 5

 Registration 5

FEATURES CHART 6

OPERATION 7

 Starting 7

 Temperature Control 7

 Quick Freeze 7

 Vacation 8

 Self Test 8

 Door Alarm 8

 Ice Making 8

 Defrosting 8

SUGGESTIONS ON FOOD STORAGE 9

LAMP REPLACEMENT 10

GENERAL INFORMATION 10

CLEANING YOUR REFRIGERATOR 11

**REPLACEMENT OF
DOOR OPENING TYPE 12**

BEFORE CALLING FOR SERVICE 14

TROUBLESHOOTING 15

REFRIGERATOR SAFETY

Your safety and the safety of others is very important.

We have provided many important safety messages in this manual and on your appliance. Always read and obey all safety messages.



This is the safety alert symbol.

This symbol alerts you to hazards that can kill or hurt you and others.

All safety messages will be preceded by the safety alert symbol and the word **DANGER** or **WARNING**. These words mean:

DANGER

You will be killed or seriously injured if you don't follow instructions.

WARNING

You can be killed or seriously injured if you don't follow instructions.

All safety messages will identify the hazard, tell you how to reduce the chance of injury, and tell you what can happen if the instructions are not followed.

IMPORTANT SAFETY INSTRUCTIONS

WARNING: To reduce the risk of fire, electric shock, or injury when using your refrigerator, follow these basic precautions:

- Plug into a grounded 3-prong outlet.
- Do not remove ground prong.
- Do not use an adapter.
- Do not use an extension cord.
- Disconnect power before servicing.
- Replace all panels before operating.
- Remove doors from your old refrigerator.
- Use nonflammable cleaner.
- Keep flammable materials and vapors, such as gasoline, away from refrigerator.
- Use two or more people to move refrigerator using handles and install refrigerator.
- Disconnect power before installing ice maker. (on some models)

SAVE THESE INSTRUCTIONS

ENGLISH

Proper Disposal of Your Old Refrigerator

DANGER

Suffocation Hazard

Remove doors from your old refrigerator. Failure to do so can result in death or brain damage.

IMPORTANT - Child entrapment and suffocation are not problems of the past. Junked or abandoned refrigerators are still dangerous - even if they will sit for just a few days. If you are getting rid of your old refrigerator, please follow these instructions to help prevent accidents.

Before you throw away your old refrigerator or freezer:

- Take off the doors.
- Leave the shelves in place so that children may not easily climb inside.

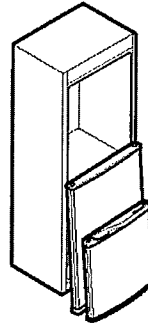

INSTALLING YOUR REFRIGERATOR

⚠ WARNING

Excessive Weight Hazard

Use two or more people to move and install refrigerator.

Failure to do so can result in back or other injury.

Unpacking Your Refrigerator

Remove tape and any temporary labels from your refrigerator before using. Do not remove any warning type labels, the model and serial number label, or the Tech Sheet that is attached to back wall of the refrigerator.

To remove any remaining tape or glue, rub the area briskly with your thumb. Tape or glue residue can also be easily removed by rubbing a small amount of liquid dish soap over the adhesive with your fingers. Wipe with warm water and dry.

Do not use sharp instruments, rubbing alcohol, flammable fluids, or abrasive cleaners to remove tape or glue. These products can damage the surface of your refrigerator. For more information, see **Important Safety Instructions** in the **Refrigerator Safety** section.

Refrigerator shelves are installed in the shipping position.

Please reinstall shelves according to your individual storage needs.

When Moving Your Refrigerator:

Your refrigerator is heavy. When moving the refrigerator for cleaning or service, be sure to protect the floor.

Always pull the refrigerator straight out when moving it.

Do not wiggle or walk the refrigerator when trying to move it, as floor damage could occur.



⚠ WARNING



Explosion Hazard

Keep flammable materials and vapors, such as gasoline, away from refrigerator. Failure to do so can result in death, explosion, or fire.

Installation

1. Avoid placing the unit near heat sources, direct sunlight, or moisture.
2. To avoid vibration, the unit must be leveled. If required, adjust the leveling screws to compensate for uneven floor. The front should be slightly higher than the rear to aid in door closing. Leveling screws can be turned easily by tipping the cabinet slightly. Turn the leveling screws clockwise () to raise the unit, counterclockwise () to lower it.
3. Install this appliance between 55 °F (13 °C) and 110 °F (43 °C.) If the temperature around the appliance is too low or high, cooling ability may lessen.

NEXT

1. Clean your refrigerator thoroughly and wipe off all dust accumulated during shipping.
2. Install accessories such as ice cube bin, drawers, shelves, etc., in their proper places. They are packed together to prevent possible damage during shipment.
3. Let your refrigerator run for 2 or 3 hours before putting food in it. Check the flow of cold air in the freezer compartment to ensure proper cooling. Your refrigerator is now ready for use.



Electrical Requirements

⚠ WARNING



Electrical Shock Hazard

- Plug into a grounded 3-prong outlet.
- Do not remove ground prong.
- Do not use an adapter.
- Do not use an extension cord.

Failure to follow these instructions can result in death, fire, or electrical shock.

Before you move your refrigerator into its final location, it is important to make sure you have the proper electrical connection:

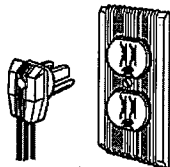

Recommended Grounding Method

A 115 Volt, 60 Hz., AC only 15 or 20 ampere fused, grounded electrical supply is required. It is recommended that a separate circuit serving only your refrigerator be provided. Use an outlet that cannot be turned off by a switch. Do not use an extension cord.

NOTE: Before performing any type of installation, cleaning, or removing a light bulb, turn the control, (Thermostat, Refrigerator, or Freezer Control depending on the model) to OFF and then disconnect the refrigerator from the electrical source. When you are finished, reconnect the refrigerator to the electrical source and reset the control (Thermostat, Refrigerator, or Freezer Control, depending on the model) to the desired setting.

Registration

The model and serial number are found on the rear of this unit. This number is unique to this unit and not available to others. You should record requested information here and retain this guide as a permanent record of your purchase. **Staple your receipt here.**

Date of Purchase : _____

Dealer Purchased From : _____

Dealer Address : _____

Dealer Phone No. : _____

Model No. : _____

Serial No. : _____

ENGLISH

FEATURES CHART

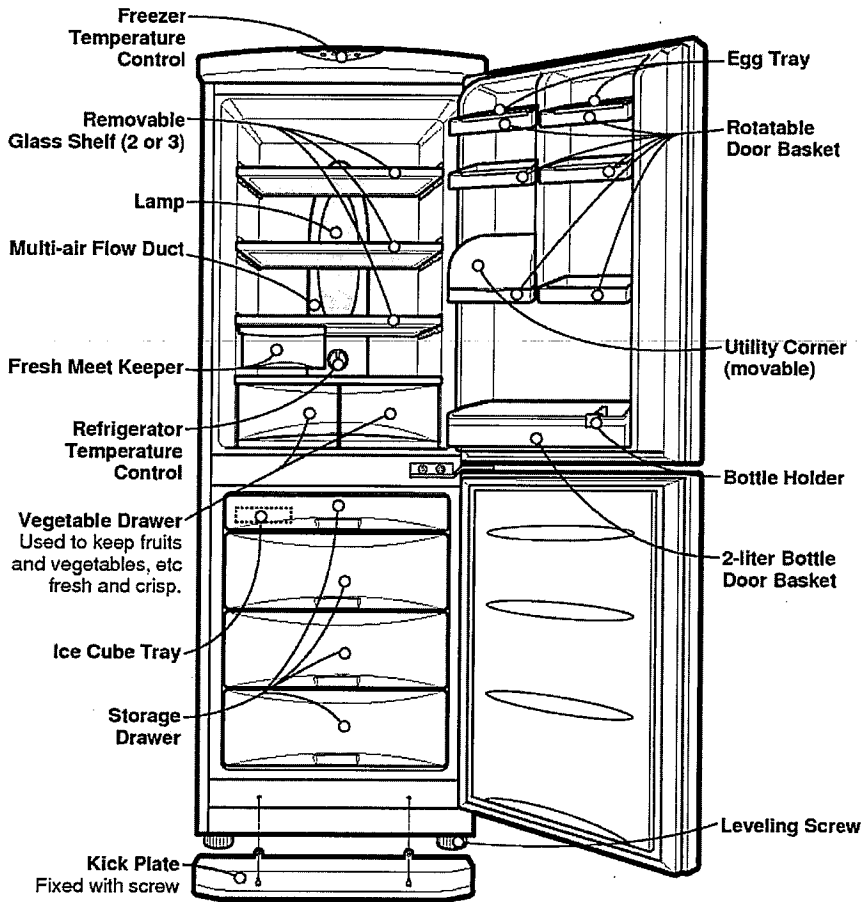

OPERATION

Starting

When your refrigerator is first installed, allow to run 2-3 hours to stabilize at normal operating temperature prior to filling it with fresh or frozen foods.

If operation is interrupted, wait 5 minutes before restarting.

Temperature Control

Your refrigerator has two controls that let you regulate the temperature in the refrigerator and freezer compartments.

REFRIGERATOR

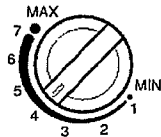

TEMP. CONTROL

- Initially set the TEMP. CONTROL at 4. Then adjust the compartment temperature according to your desire.
- If you want an inside temperature slightly less cold or colder, turn the knob towards MIN or MAX, respectively. When the surrounding temperature is low, adjust the TEMP. CONTROL MIN.

FREEZER

- Freezer temperature control is on the top of the Refrigerator-Freezer. Initially set the Freeze Temp at mid-point. By pressing the Freeze Temp button, you can adjust the temperature of the Freezer as indicated by the numbers of lamps lit. (The setting is composed of five steps; 5 lamps lit indicates coldest.)
- When you starting the Refrigerator-Freezer or connecting the power plug to the outlet, temperature setting is automatically set to the mid-point.

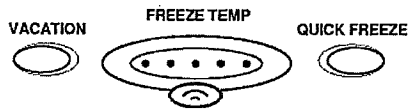

- When the button is pushed, the buzzer sounds.

Quick Freeze

- This function is used when you want to freeze the foods quickly. Press the QUICK FREEZE button once, and then the quick freeze operation starts with the lamp lit. The quick freeze operation takes about 3 hours. When its operation ends, it automatically returns to the normal state. If you want to stop the quick freeze operation, press the QUICK FREEZE button once more, the lamp goes out, and the quick freeze operation stops and the refrigerator returns to the normal state.

QUICK FREEZE

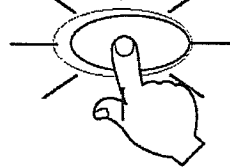

ENGLISH

Vacation

This function makes the Refrigerator-Freezer work in a power saving mode which is useful for when you are away on holiday, by reducing energy consumption as much as possible. Pressing VACATION starts operation with lamp ON and pressing it again stops the operation. For better functioning, you should set the TEMP. CONTROL to MIN.



Ice Making

- To make ice cubes, fill the ice tray to the water level and place it in the freezer.
- If ice cubes are required quickly, press the QUICK FREEZE button.
- To remove ice cubes, hold the tray at its ends and twist gently.

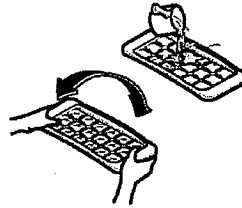

Self Test

This function allows you to check for operational problems. If you think you have a problem with your Refrigerator-Freezer, then press the temperature control button:

- Indicator lights move up or down, then there is no problem with your Refrigerator-Freezer.
- Indicator lights do not move up or down, then please leave the power connected and call your nearest service agent.

TIP

To remove ice cubes easily, run water on the tray before twisting.

Defrosting

Defrosting takes place automatically. Defrosted water flows down to the evaporating tray which is located in the lower back side of the refrigerator and is evaporated automatically.

Door Alarm

When the door of the Refrigerator is left opened for a while, the alarm sounds.

SUGGESTIONS ON FOOD STORAGE

Storing Food

- Do not store food which goes bad easily at low temperature, such as bananas, pineapples, and melons.
- Allow hot food to cool prior to storing. Placing hot food in the refrigerator could spoil other food, and lead to higher electric bills!
- When storing, wrap food in vinyl, or place in a covered container. This prevents moisture from evaporating, and helps food to keep its taste and nutritional value.
- **It is desirable to store moist food (especially vegetable and fruit) in the vegetable compartment.**
If it is necessary to store on a shelf of the refrigerator, put it close to the door away from the back wall of the refrigerator to avoid being frozen by the cool circulating in the refrigerator.

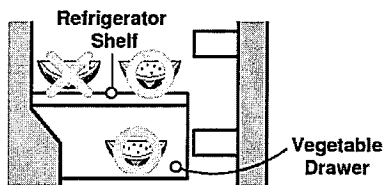

- Do not block air vents with food. Smooth circulation of cold air keeps the refrigerator temperature even.
- Do not open the door frequently. Opening the door lets warm air enter the refrigerator, and cause temperature to rise.
- To adjust the temperature control easily, do not store food near the temperature control dial.
- Never keep too many foods in door rack, as this may stop the door from closing fully.
- Do not store bottles in the freezer compartment - they may break when frozen.
- Do not refreeze food that has been thawed. This causes loss of taste and nutritional value.

NOTE

- If you keep the refrigerator in a hot and humid place, frequently opening the door or putting a lot of vegetables in it may cause condensation to form. This has no effect on its performance. Remove the condensation with a dry, dust-free cloth.
- If droplets form beneath the cover of the vegetable drawer, keep vegetables or fruits wrapped with plastic wrap.

ENGLISH

LAMP REPLACEMENT

1. Unplug the power cord from the outlet.
2. Remove refrigerator shelves.
3. To remove the lamp cover, insert \ominus type driver in the underside of the lamp cover and pull it out forwards.
4. Turn the lamp counterclockwise.
5. Assemble in reverse order of disassembly. Replacement lamp must be the same specification as original. (Max 40W)

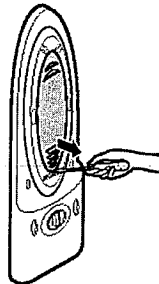

GENERAL INFORMATION

Vacation Time

During average length vacations, you will probably find it best to leave the refrigerator in operation. Place freezable items in freezer for longer storage. When you plan to be away for an extended period,

- Disconnect the power cord or set refrigerator Dial knob to off position.
- Remove all food and other items from the unit.
- Clean the unit thoroughly.
- Leave the shelves in the unit to discourage children from playing in the unit.
- Leave the doors open and block them to ensure that they cannot be closed.

Power Failure

Most power failures are corrected in an hour or two and will not affect your refrigerator temperatures. However, you should minimize the number of door openings while the power is off. During power failures of longer duration, place a block of dry ice on top of your frozen packages.

If You Move

Remove or securely fasten down all loose items inside the refrigerator.

To avoid damaging the leveling screws, turn them all the way into the base.

Anti-Condensation Pipe

The outside wall of the refrigerator cabinet may sometimes get warm, especially just after installation. Don't be alarmed. This is due to the anti-condensation pipe, which pumps hot refrigerant to prevent sweating on the outer cabinet wall.

Anti-Condensation Pipe

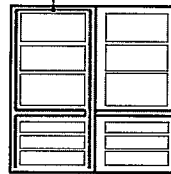

CAUTION

- Dry ice is very cold! Do not allow it to touch bare skin. It is well below 0 °F and will cause immediate frostbite and damage to the skin and other tissue.
- Dry ice is frozen carbon dioxide. Use only in a well ventilated area. As the ice releases carbon dioxide vapor, it could cause light-headedness, fainting, suffocation, or death.

CLEANING YOUR REFRIGERATOR

⚠ WARNING



Explosion Hazard

Use nonflammable cleaner.

Failure to do so can result in death, explosion, or fire.

Both the refrigerator and freezer sections defrost automatically. However, clean both sections about once a month to prevent odors from building up. Wipe up spills immediately.

To clean your refrigerator.

- Unplug refrigerator or disconnect power.
- Remove all removable parts from inside, such as shelves, crispers, etc.
- Use a clean sponge or soft cloth and a mild detergent in warm water. Do not use abrasive or harsh cleaners.
- Hand wash, rinse, and dry all surfaces thoroughly.
- Plug in refrigerator or reconnect power.

■ Additional cleaning tips are listed below:

PART	COMMENTS
Outside	<ul style="list-style-type: none"> ■ Waxing external painted metal surfaces helps provide rust protection. Do not wax plastic parts. Wax painted metal surfaces at least twice a year using appliance wax (or auto paste wax). Apply wax with a clean, soft cloth. ■ For products with a stainless steel exterior, use a clean sponge or soft cloth and a mild detergent in warm water. Do not use abrasive or harsh cleaners. Dry thoroughly with a soft cloth.
Inside walls (allow freezer to warm up so cloth won't stick)	<ul style="list-style-type: none"> ■ To help remove odors, you can wash the inside of the refrigerator with a mixture of baking soda and warm water. Mix 2 tablespoons soda to 1 quart of water (26 g soda to 1 liter water.) Be sure the soda is completely dissolved so it is not abrasive and doesn't scratch the surfaces of the refrigerator.
Door liners and gaskets	<ul style="list-style-type: none"> ■ Do not use cleaning waxes, concentrated detergents, bleaches, or cleaners containing petroleum on plastic parts.
Plastic parts (covers and panels)	<ul style="list-style-type: none"> ■ Do not use paper towels, window sprays, abrasive cleansers, or flammable fluids. These can scratch or damage material.
Condenser coils	<ul style="list-style-type: none"> ■ Remove base grille. (See the Base grille section on page 6.) ■ Use a vacuum with an extended attachment to clean condenser coils. ■ Vacuum coils when dusty or dirty. Coils may need to be cleaned as often as every other month. ■ Replace base grille.

ENGLISH

REPLACEMENT OF DOOR OPENING TYPE

⚠ PRECAUTION

1. Before replacing the door opening type, first of all, you should take out of food and accessories like shelves or trays, which are not fixed in the refrigerator.
2. Use a '+ Driver, Bolt Driver, Torque Wrench or Spanner to fix or remove the bolt.
3. Be careful not to tip over the refrigerator in disassembling or assembling the Lower Hinge and the Adjustable Screw Asm. Don't lay the refrigerator down when working it will cause it to malfunction.
4. Be careful not to drop the door in disassembling or assembling the freezer or the refrigerator door.
5. This refrigerator, according to the installation position or user's preference can have the door opening from the right or left.

How to Replace the Door Opening Left to Right (when converting from the left-opening type to right opening type)

How to Reverse the Doors

1. Remove screw ② and cover ①.
Remove cap cover ③, hinge-L ⑤, and pin ④.
Remove the freezer door.
Move cap ⑦ to the side not used.
Move hinge ⑧ and screw ⑨ to the side you wish and reinstall.

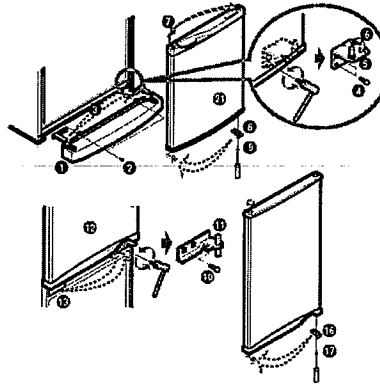

2. Remove bolt ⑩ and hinge-C ⑪ and take off refrigerator door ⑫.
Move cap ⑬ to the side not used.
Move door bracket ⑭ and screw ⑰ to the side you wish and reinstall.

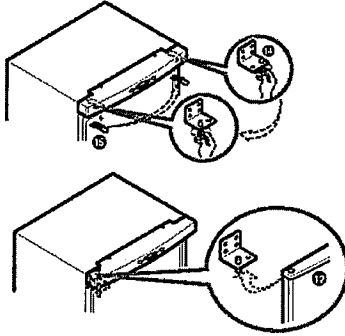

After Completing the job

- Make sure that the four corners of the door gasket are not folded. It is recommended to apply a small amount of silicon grease on them.
- Adjust the leveling screw on the bottom to the highest level so that the front side of the refrigerator is higher than the rear side.
- If you need assistance after switching the direction of the door opening as shown above, call a service center.

NOTE

Reversing the doors is not covered by the warranty.

3. Move hinge-U pin ⑮ and top cover cap ⑯.
Assemble the refrigerator door ⑰.
Assemble hinge-C ⑱ and bolt ⑲.
Assemble freezer door ⑳.
Assemble the hinge-L ㉑ and bolt ㉒.
Assemble base cover ㉓ and screw ㉔.

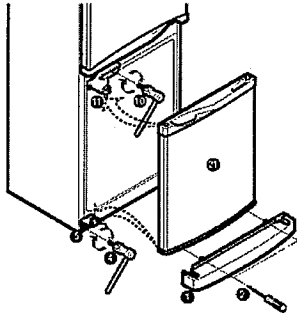

ENGLISH

BEFORE CALLING FOR SERVICE

SERVICE CALLS CAN OFTEN BE AVOIDED!
IF YOU FEEL YOUR REFRIGERATOR IS NOT OPERATING PROPERLY, CHECK THESE POSSIBLE CAUSES FIRST:

PROBLEM	POSSIBLE CAUSES
REFRIGERATOR DOES NOT OPERATE	<ul style="list-style-type: none"> ■ Has a house fuse blown or circuit breaker tripped? ■ Has the power cord plug been removed or loosened from the electrical wall outlet?
REFRIGERATOR OR FREEZER COMPARTMENT TEMPERATURE TOO WARM	<ul style="list-style-type: none"> ■ Temperature control not set on proper position. ■ Appliance is placed close to wall or heat source. ■ Warm weather-frequent door openings. ■ Door is not closed entirely. ■ Door left open for a long time. ■ Large amount of foods are kept in the refrigerator.
ABNORMAL NOISE(S)	<ul style="list-style-type: none"> ■ Refrigerator is installed in a weak or uneven place or leveling screw needs adjusting. ■ Unnecessary objects placed in the back side of the refrigerator.
REFRIGERATOR HAS ODOR	<ul style="list-style-type: none"> ■ Foods with strong odors should be tightly covered or wrapped. ■ Interior needs cleaning.
DEW FORMS ON THE CABINET SURFACE	<ul style="list-style-type: none"> ■ Not unusual during periods of high humidity. ■ Door may have been left ajar.

Customer Assistance Numbers:

- To Prove Warranty Coverage
Retain your Sales Receipt to prove date of purchase.
A copy of your Sales Receipt must be submitted at the time warranty service is provided.
- To Obtain Product, Customer or Service Assistance
Call Toll-free for Customer Service
Tel : 1-800-243-0000
- To Obtain Nearest Authorized Service Center
Call 1-800-243-0000, push option #1, 24 hours a day, 7 days per week.
Please have your product type (Monitor, TV, VCR, MWO, Refrigerator) and ZIP code ready.

TROUBLESHOOTING

PROBLEM	POSSIBLE CAUSES
REFRIGERATOR-FREEZER DOES NOT OPERATE	<ul style="list-style-type: none"> ■ Power plug may be unplugged from the electric outlet. Plug it in securely. ■ House fuse has blown or circuit breaker has tripped. Check and/or replace fuse and reset circuit breaker. ■ Power cut. Check house lights.
REFRIGERATOR OR FREEZER COMPARTMENT TEMPERATURE TOO WARM	<ul style="list-style-type: none"> ■ Temperature control not set on proper position. Refer to Temperature Control section. ■ Appliance is placed close to heat source. ■ Warm weather-frequent door openings. ■ Door left open for a long time. ■ Package holding door open or blocking air duct in freezer compartment.
VIBRATION OR RATTLING OR ABNORMAL NOISE	<ul style="list-style-type: none"> ■ The floor on which the Refrigerator-Freezer is installed may be uneven or the Refrigerator-Freezer may be unstable. Make it even by rotating the leveling screw. ■ Unnecessary objects placed in the back side of the Refrigerator-Freezer.
FROST OR ICE CRYSTALS ON FROZEN FOOD	<ul style="list-style-type: none"> ■ Door may have been left ajar or package holding door open. ■ Too frequent or too long door openings. ■ Frost within package is normal.
MOISTURE FORMS ON CABINET SURFACE	<ul style="list-style-type: none"> ■ This phenomenon is likely to occur in a wet space. Wipe it with a dry towel.
MOISTURE COLLECTS INSIDE	<ul style="list-style-type: none"> ■ Too frequent or too long door openings. ■ In humid weather, air carries moisture into refrigerator when doors are opened.

ENGLISH



PROBLEM	POSSIBLE CAUSES
REFRIGERATOR HAS ODOR	<ul style="list-style-type: none">■ Foods with strong odors should be tightly covered or wrapped.■ Check for spoiled food.■ Interior needs cleaning. Refer to CLEANING section
DOOR NOT CLOSING PROPERLY	<ul style="list-style-type: none">■ Food package is keeping door open. Move packages that keep door from closing.■ Refrigerator-Freezer is not level. Adjust the leveling screws.■ The floor on which the Refrigerator-Freezer is installed may be uneven or the Refrigerator-Freezer may be unstable. Slightly raise the front side with the leveling screw.
INTERIOR LIGHT DOES NOT WORK	<ul style="list-style-type: none">■ No power at outlet.■ Light lamp needs replacing. Refer to the Lamp Replacement section

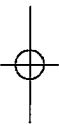

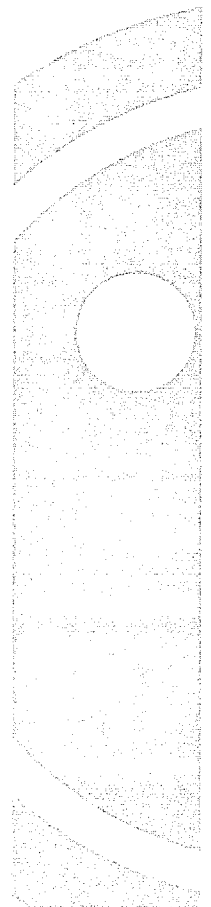
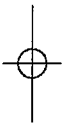
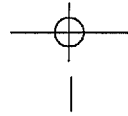

P/No. 3828JD8400A (Rev. 00)

Printed in Korea

