

## Operating instructions

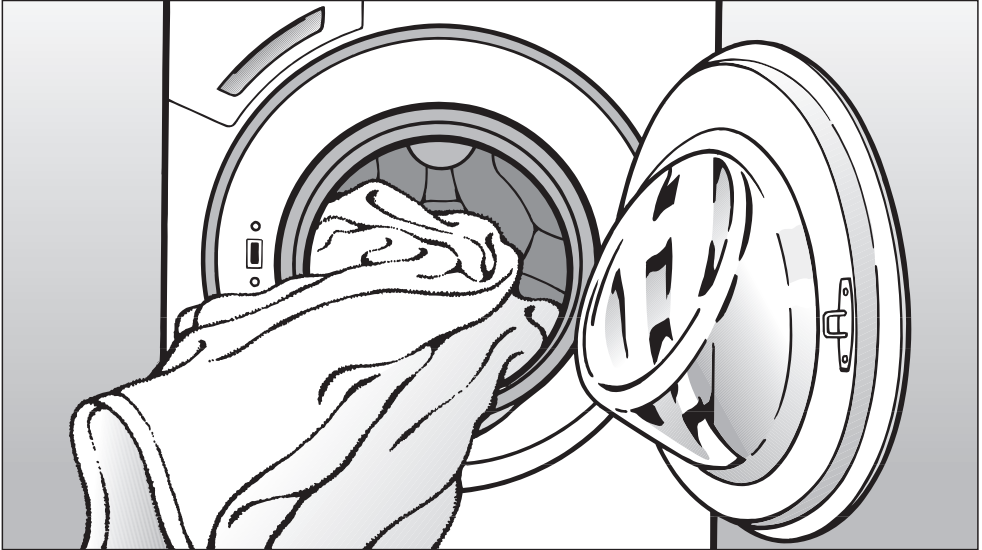

## Washing machine W 1753

To avoid the risk of personal injury or damage to the appliance, it is **essential** that you read these operating instructions **before** installation and use. This machine is not approved for use in the United States.

en - CA

M.-Nr. 10 210 871

# Caring for the environment

---

## Disposal of packing materials

The packing materials protect the washer from damage during shipping. They have been selected with an eye to environmental compatibility and efficient disposal, and should be recycled.

Returning packaging to the materials cycle helps conserve raw materials and reduces waste. The packing materials can be returned to your dealer.

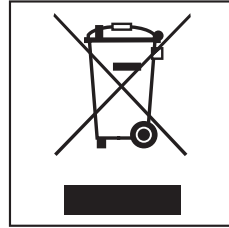

## Disposing of your old appliance

Old electric and electronic equipment often contains valuable materials. However, they may also contain harmful substances that were necessary for safe use. Improperly disposing of these items in your household waste can be detrimental to health and the environment. This is why it is important **NEVER** to dispose of your old appliance with the regular household garbage.



Instead, please contact your local community waste collection point to return and recycle electric and electronic appliances. Your dealer should be able to provide you with details.

If the appliance is being stored for disposal, please make sure it has been child-proofed.

<b>Caring for the environment</b> . . . . .	2
<b>Important safety instructions</b> . . . . .	6
<b>Operating the washing machine</b> . . . . .	10
Control panel . . . . .	10
<b>Before using for the first time</b> . . . . .	12
<b>Environmentally friendly use</b> . . . . .	13
Energy and water consumption . . . . .	13
Detergent consumption . . . . .	13
<b>How to wash correctly</b> . . . . .	14
Brief instructions . . . . .	14
<b>Spin cycles</b> . . . . .	19
Final spin cycle speed . . . . .	19
Rinse cycle spins . . . . .	19
De-select final spin  (Rinse hold) . . . . .	19
De-select the rinse spin(s) and final spin (none  ) . . . . .	19
<b>Program overview</b> . . . . .	20
<b>Extra options</b> . . . . .	22
<b>Garment care label symbols</b> . . . . .	23
<b>Program sequence</b> . . . . .	24
<b>Changing a program sequence</b> . . . . .	26
Canceling a program . . . . .	26
Interrupting a program . . . . .	26
Changing a program . . . . .	26
Loading or removing laundry . . . . .	27
Childproof lock . . . . .	27

# Contents

---

<b>Detergent</b> . . . . .	28
Selecting the right detergent . . . . .	28
Water softener . . . . .	29
Washing with several components . . . . .	29
Fabric softener, fabric shaper, and liquid starch . . . . .	30
Automatic dispensing of fabric softener, fabric shaper, or liquid starch . . . . .	30
Dyes and dye removers. . . . .	30
<b>Cleaning and care</b> . . . . .	31
Cleaning the drum . . . . .	31
Cleaning the housing and control panel . . . . .	31
Cleaning the dispenser drawer . . . . .	31
Cleaning the water inlet filters . . . . .	33
<b>Troubleshooting</b> . . . . .	34
What to do if . . . . .	34
No wash program will start . . . . .	34
Fault messages in the display . . . . .	35
General problems . . . . .	36
Unsatisfactory wash results . . . . .	37
The loading door cannot be opened with the Door button . . . . .	38
Opening the loading door (blocked drain outlet and/or power outage) . . . . .	39
<b>Customer service</b> . . . . .	41
Repairs . . . . .	41
Program updates (PC) . . . . .	41
Additional accessories . . . . .	41
<b>Installation and connection</b> . . . . .	42
Front view . . . . .	42
Rear view . . . . .	43
Installation surface . . . . .	44
Transporting the washing machine to its installation site . . . . .	44
Removing the transit bars . . . . .	44
Re-fitting the transit bars . . . . .	46

Levelling the machine . . . . .	47
Screw out and adjust the feet . . . . .	47
Installing under a countertop . . . . .	48
Washer-dryer stack . . . . .	48
The Miele water protection system . . . . .	49
Connecting to the water supply . . . . .	49
Tap water line (cold water) . . . . .	50
Hot water connection . . . . .	50
Drainage system . . . . .	51
Electrical connection . . . . .	52
ELECTRICAL INSTRUCTIONS . . . . .	52
"EASY INSTALLATION KIT" . . . . .	52
<b>Technical data</b> . . . . .	<b>53</b>
<b>Programmable functions</b> . . . . .	<b>55</b>
To access programmable functions . . . . .	55
To select a programmable function . . . . .	55
To change a programmable function . . . . .	55
To exit a programmable function . . . . .	55
Language  . . . . .	55
Gentle wash . . . . .	56
Suds cooldown . . . . .	56
Pin code . . . . .	57
Temperature unit . . . . .	58
Buzzer . . . . .	58
Keypad tone . . . . .	58
Brightness . . . . .	58
Contrast . . . . .	58
Standby display . . . . .	59
Memory . . . . .	59
Anti-crease . . . . .	59

# Important safety instructions

---

This washer complies with all applicable safety laws and regulations. Inappropriate use can, however, lead to personal injury and property damage.

Please thoroughly read these instructions before first using the appliance. They contain important information on the safe installation, operation, and care of your appliance. They are intended to help prevent personal injury and damage to the appliance.

Keep these operating instructions in a safe place and pass them on to any future owner.

The W 1753 meets all CSA requirements. This machine is not approved for use in the United States.

► Individuals who are incapable of using the appliance safely because of reduced physical, sensory or mental capabilities, or because of a lack of experience or knowledge, must not use this appliance without supervision or instruction by a responsible person.

## Children around the appliance

► Supervise any children in the vicinity of the appliance. Never allow children to play with the appliance.

► Children must not use the washer unsupervised unless they have received sufficient instruction to operate it safely. They must be able to recognize the potential hazards of improper operation.

► Remember that high wash temperatures will make the porthole glass hot. Teach children not to touch the glass while the washer is in operation.

## Proper use

► The washing machine is designed for household use only and only for washing textiles whose fabric care label states that they can be washed. Other uses may be dangerous. Miele will not be held liable for damage caused by improper use or incorrect operation.

## Technical safety

▶ Check the washer for externally visible damage before installation. Do not install or operate a damaged washer.

▶ Before plugging in the appliance, you must make sure that the electrical rating (fuse amperage, voltage and connected load in watts, indicated on the data plate) matches the household electrical supply. If in any doubt, consult a qualified electrician.

▶ The washer can only be considered safe if it has been connected to a properly installed grounding system, as per code.

It is crucial to have this essential safety requirement tested, and to have the household wiring checked by a professional if there is any doubt. Miele will not be held liable for any damage or harm caused by a missing or incomplete grounding system.

▶ For safety reasons, do not use extension cords (danger of fire from overheating).

▶ Use only genuine Miele replacement parts to replace defective components. Only these parts are guaranteed to meet applicable safety requirements.

▶ Unauthorized repairs may create unforeseeable risks for the user, for which Miele assumes no liability. Repairs should be carried out only by authorized Miele technicians - otherwise, associated damage will not be covered by the warranty.

▶ If the power cord is damaged it must be replaced by an authorized Miele technician to prevent danger to the user.

▶ In the event of a fault, or for care and cleaning, the washer is only considered disconnected from the power supply, when

- the plug is completely removed from the socket, or
- the circuit breaker for the house wiring system is completely shut off, or
- the screw-out fuse in the house wiring system is unscrewed and removed.

▶ Use only a new hose kit to attach the washer to the household water supply. Old hosing should not be re-used.

# Important safety instructions

---

▶ The appliance is not designed for use in non-stationary locations (for example, on ships). However, this use may be possible if a qualified specialist determines that the appliance can be used safely in the location in question.

▶ Make no modifications to the washer that are not expressly authorized by Miele.

## Proper use

▶ Do not place the washer in a room where there is a risk of frost occurring. Frozen hoses can split or burst, and the reliability of the electronics can be reduced below the freezing point.

▶ Before using the washer for the first time, remove the shipping rods on the back of the appliance (see "Installation and connection" under "Removing the transport fittings"). Failure to remove the shipping rods can damage the washer and any surrounding furniture or devices during spinning.

▶ For extended absences (e.g., a vacation), close the taps, especially if there is no gully near the washer.

▶ **Danger of flooding!**

Before hanging the drain hose in the washbasin, make sure the water will drain away quickly enough. Secure the hose from slipping. The force of the water exiting the hose can cause an unsecured hose to pop out of the basin.

▶ Ensure that no foreign bodies (e.g., nails, needles, coins, paper clips) are in the wash. Foreign bodies can damage the appliance components (e.g., suds container, washer drum). Damaged components, in turn, can damage laundry items.

▶ Proper dosing of the detergent will eliminate the need to remove lime deposits. However, if heavy limescale nonetheless forms on your washer, be sure to select a special descaling agent with corrosion protection. This special product can be obtained from your Miele dealer or from Miele Customer Service. Closely follow the instructions on the product package.



# Important safety instructions

---

- ▶ Textiles that have been pre-treated with solvent-based cleaners must be rinsed thoroughly in water before you wash them.
- ▶ NEVER use solvent-based cleaners (e.g., benzine) in the washing machine. The use of such products can damage the appliance and generate noxious fumes. Fire hazard and danger of explosion!
- ▶ NEVER use solvent-based cleaners (e.g., benzine) on or around the washing machine. Splatters can damage the plastic surfaces of the appliance.
- ▶ Do not use dyes unless they are recommended for use in washing machines. Dyes are to be used in reasonable (household) quantities only. Closely follow the manufacturer's instructions.
- ▶ Colour removers contain sulphur compounds, which can lead to corrosion. Therefore, do not use colour removers in the washer.
- ▶ If liquid detergent comes into contact with the eyes, immediately flush with copious amounts of lukewarm water. If accidentally swallowed, immediately seek medical attention. Persons with sensitive or damaged skin should avoid contact with liquid detergents.

## Accessories

- ▶ Only use accessories that are expressly authorized by Miele. If other parts are used, the appliance warranty and any associated performance and/or product liability claims become null and void.

The manufacturer will not be held liable for damage caused by failure to comply with the safety instructions and warnings.

# Operating the washing machine

## Control panel

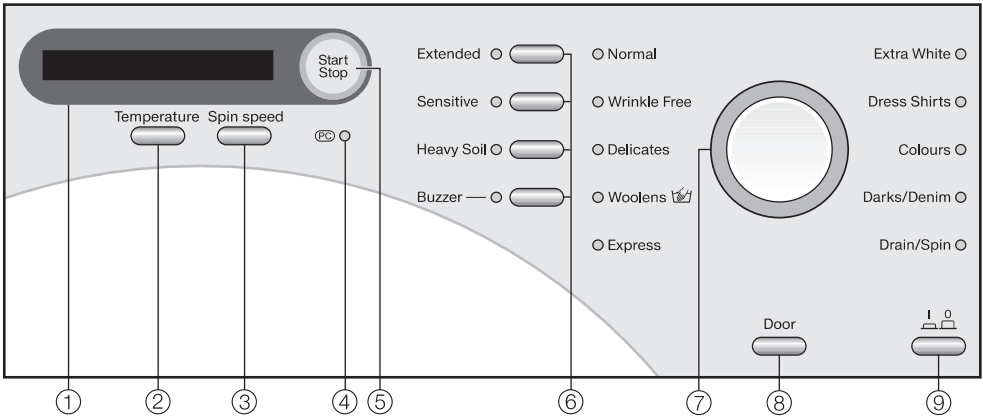

### ① **Display**

See the following page for more information.

### ② **Temperature button**

For selecting a temperature.

### ③ **Spin speed button**

For selecting the final spin speed or *Rinse hold* or *No*  (de-select spin).

### ④ **PC / Optical interface**

Used by Customer Service for diagnostic checks and programming updates.

### ⑤ **Start/Stop button**

Starts the selected wash program or stops a started program.

### ⑥ **Extra option buttons**

Various extras can be added to the wash programs.

### ⑦ **Program selector**

For selecting a program. The indicator light next to the selected program comes on. The program dial can be turned right or left.

### ⑧ **Door button**

Opens the drum door.

### ⑨ **button**

For switching the machine on or off.

# Operating the washing machine

---

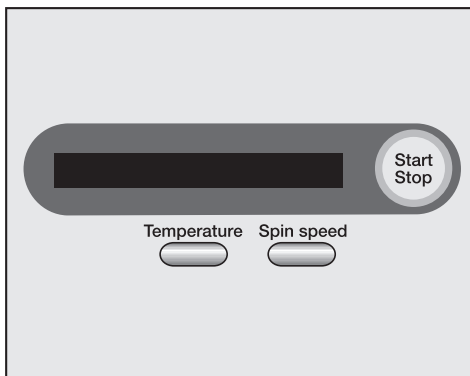

## Program duration

Once a program starts, the estimated program duration (in hours and minutes) is displayed.

During the first 8 minutes of the program, the washer calculates the quantity and absorbency of the laundry. This can cause an increase or decrease in program times.

## Programmable functions

The programmable functions can be used to adapt the washer to your personal requirements. In programming mode, the display will show the function selected.

The following functions are selected from the display:

- wash temperature
- spin speed
- programmable functions
- program cancel
- childproof (safety) lock

The display also shows:

- program duration
- program sequence

## Before using for the first time

---

Before the washer is used for the first time, it needs to be properly installed and connected. See "Installation and connection".

Because the washer was put through a complete operational test in the factory, there will be some water left in the drum.

For safety reasons, the washer will not spin until it has been prepared for use. To activate the spinning function, you will need to run a wash program without laundry and without detergent.

If you use detergent, it will cause excessive sudsing.

This preparation step also activates the ball valve in the drain. Once activated, the ball valve helps prevent detergent escaping from the suds container into the drain during a wash program, thus ensuring maximum use of the detergent.

- Press the  button in.

If the washer is being switched on for the first time, the welcome screen will appear.

The welcome screen will appear in the display every time the washer is switched on, until a program lasting longer than 1 hour has been completed.

### Setting the language

You will be prompted to select the desired display language. You can change the language at any time through the programmable functions.

 deutsch

- Turn the program selector to select the desired display language. Use the *Start/Stop* button to confirm your selection.

### Reminder to remove the shipping rods

The shipping rods must be removed before the washer is used for the first time, to help prevent damage to the appliance.

- After removing the shipping rods, press the *Start/Stop* button.

### Running the washer for the first time

Run a *Extra White 60°C* with no laundry and no detergent. (This program is automatically selected.)

- Open the faucets.
- Press the *Start/Stop* button.
- Once the program is finished, switch the washer off.

The washer is now ready for regular use.

# Environmentally friendly use

---

## Energy and water consumption

- To make the most out of each wash load, load the maximum dry weight for the program you have selected.
- Use the *Colours* and *Express* programs for small loads.
- When smaller amounts of laundry are washed using the *Normal* program, the automatic load recognition system will automatically reduce the water, energy, and time for that load. This may cause a correction in the remaining time displayed for the wash.
- To save energy, all wash programs with a temperature setting of 40°C or above will draw from the hot water supply. The only exception is the Wool program, which protects garments by avoiding the use of hot water.

## Detergent consumption

- Do not exceed the maximum detergent dose listed on the package.
- Adjust the detergent dose to suit how soiled the laundry is.
- For smaller loads, reduce the amount (approx.  $\frac{1}{3}$  less detergent for a half load).

## Choosing the right extra options (Extended and Pre-wash)

Select:

- a wash program together with NO extra option for lightly to moderate soiled items with no obvious staining
- a wash program with *Extended* extra options for moderate to heavy soiling with visible staining.
- The *Heavy Soil* extra option for laundry with large amounts of dirt (e.g., dust, sand).

## When drying with a tumble dryer

To help save energy when using a dryer, select the highest possible spin speed for the wash program in question.

# How to wash correctly

## Brief instructions

The bold headings numbered (1, 2, 3, ...) show the overall sequence of steps, and may be used as short-cut instructions.

### 1 Prepare the laundry

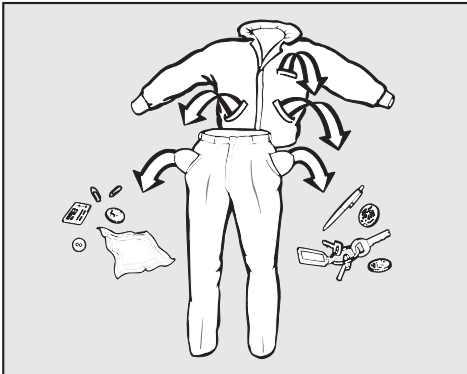

- Empty all pockets.

⚠ Foreign objects (e.g., nails, coins, paper clips) can damage garments and the washer itself.

### Pre-treat stains

- Before washing, treat fabrics to loosen stains; it is best to do so while the stains are still fresh. Blot stains with a colourfast cloth to remove. Do not rub.

Common stains (blood, egg, coffee, tea, etc.) can typically be addressed with the help of the Miele laundry care guide. For a copy, contact Miele directly, or visit the Miele Website.

⚠ When pre-treating fabrics with solvent-based products (gasoline, for example), make sure that the product does NOT come into contact with any plastic parts.

⚠ NEVER use solvent-based cleaners (e.g., gasoline, cleaner's solvent) on or around the washing machine.

### Sort the laundry

- Sort garments by colour and care requirements (see collar or side seam for garment tags).

Dark items may bleed colour for the first few washes. To avoid staining, take care to wash light and dark items separately.

### General information:

- Curtains: Remove any curtain hardware or weights, or tie the curtains in a laundry bag.
- Stitch down or remove any loose underwires in bras.
- Close any zippers, hooks and eyes before washing.
- Close duvet covers and pillowcases to prevent small items from getting inside.

Do not wash items that are labelled **Do not wash** (Care symbol .

# How to wash correctly

## 2 Switch the washer on

## 3 Load the washer

- Press the *Door* button to open the drum door.
- Unfold the laundry and load it loosely into the drum. Mixing both large and small items in a load gives better wash results and helps distribute the load evenly during the spin cycle(s).

Loading to the maximum listed amount helps keep energy and water consumption as low as possible, proportionate to other load sizes. However, overloading diminishes wash performance and leads to creasing.

Check that no items are trapped between the drum door and the door seal.

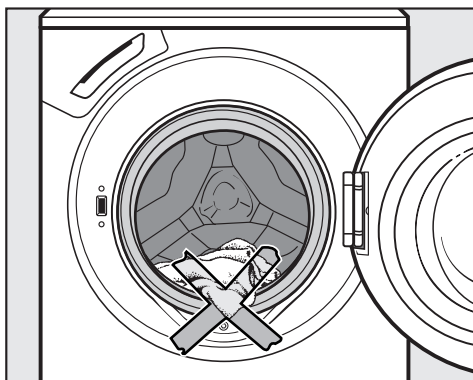

- Gently swing the loading door shut.

## 4 Select program



- Turn the program selector right or left to select the desired program. A program is selected when the indicator light next to the program name is on.

## 5 Select a temperature / spin speed

You can modify the suggested temperature and/or spin speed.

1:01 40° 1500

- Press the *Temperature* button to change the temperature, and press the *Spin* button to alter the spin speed.

# How to wash correctly

---

## ⑥ Select extra options

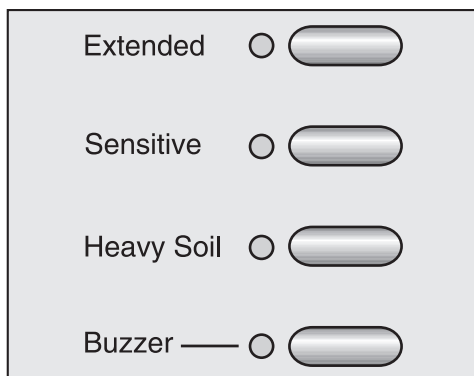

- Use the corresponding button to select any desired extras. When an extra is selected, the matching indicator light comes on.

Not all extras can be selected in every wash program.

If an extra cannot be selected, it is not compatible with the program you wish to run.

### **Extended**

The wash time is extended. Intended for more heavily soiled garments.

### **Sensitive**

An additional final rinse washes away detergent residue and scents.

An additional rinse takes place.

### **Heavy Soil**

For heavily soiled laundry or stubborn dried on stains.

A pre-wash takes place and the wash time for the main wash is extended.

### **Buzzer**

You will hear a buzzer sound at the end of a program and when Rinse hold is reached. The buzzer continues to ring until the washer is turned off. You can adjust the volume of the buzzer as described in the section on "Programmable functions".



## How to wash correctly

### 7 Add detergent

It is important to use the right amount, because . . .

. . . too little detergent results in:

- the laundry not getting clean, and turning grey and stiff over time
- greasy deposits on the laundry
- limescale deposits on the heating element

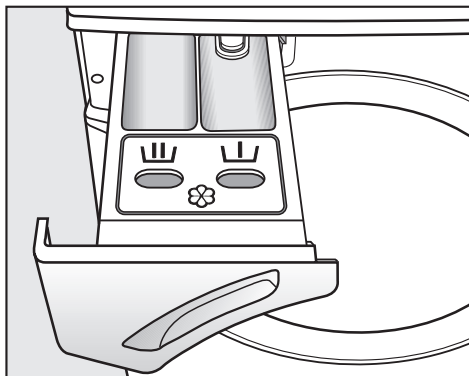

. . . too much detergent results in:

- excessive sudsing, which interferes with proper agitation and leads to poor wash, rinse, and spin results
- increased water consumption because of an automatic additional rinse cycle
- a burden to the environment



- Pull out the detergent drawer and fill with product, as follows:



Detergent for the pre-wash (we recommend dividing the total detergent amount as follows:  $\frac{1}{3}$  in compartment  and  $\frac{2}{3}$  in compartment )



Detergent for the main wash



Fabric softener or liquid starch

- Close the detergent drawer.

Additional information regarding laundry products and doses can be found in the "Detergent" section.

# How to wash correctly

## 8 How to start a program

- Press the flashing *Start/Stop* button.

The estimated program duration will appear in the display as soon as the program has started. During the first 8 minutes of the program, the washer calculates how much water is needed, based on the absorbency of the laundry. This can result in shorter or longer program times.

The program sequence will also appear in the display. The washer will show which program step is currently running.

## 9 Remove the laundry when the program is finished

In crease-free mode, the display alternates between:

0:00 Anti-crease

and

0:00 Finish

- Press the *Door* button to open the drum door.
- Remove the laundry.

Check that all items have been removed from the drum. Items left behind could shrink or bleed colour during the next load.

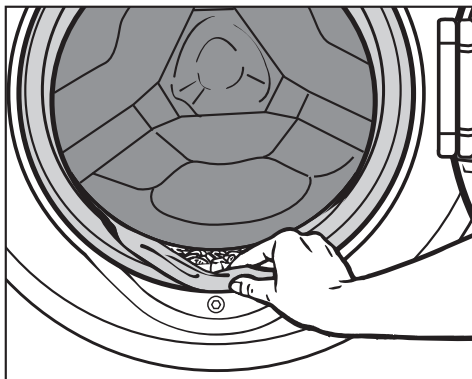

- Check the folds in the door seal for foreign objects.
- Use the  button to switch the washer off.
- Close the door. If it is left open, objects may inadvertently be placed in the drum. They could be washed in the next load and damage the laundry.

## Final spin cycle speed

Program	RPM
Normal	1500
Wrinkle Free	1200
Delicates	600
Woolens	1200
Express	1500
Extra White	1500
Dress Shirts	600
Colours	1200
Darks/Demin	1200
Drain/Spin	1500

You can reduce the final spin cycle speed.

It is not possible to select a higher final spin cycle speed than indicated above.

## Rinse cycle spins

The laundry is spun after the main wash and between the rinse cycles. If you reduce the final spin cycle speed, the rinse cycle spin speed is reduced along with it.

## De-select final spin (Rinse hold)

■ Use the *Spin speed* button to select the  feature. After the last rinse cycle, the laundry remains in the water. This helps reduce creasing if the laundry cannot be immediately removed from the drum upon program completion.

### – Start the final spin:

The washer automatically offers you the highest possible spin speed. However, you can select a lower speed (RPM). Use the *Start/Stop* button to start the final spin.

### – End the program:

Press the *Door* button. The water is pumped away. Next, press the *Door* button again to open the loading door.

## De-select the rinse spin(s) and final spin (none )

■ Use the *Spin speed* button to select the *none*  feature. After the last rinse cycle, the water is pumped away and wrinkle protection is activated. If this setting is used in the *Wrinkle free*, *Express* or *Colours* programs, an extra rinse cycle will be added.

## Program overview

<b>Normal</b> <b>50°C to cold</b>	
Fabric	Items made from cottons, linen or mixed fabrics
Note:	It is not possible to modify the spin speed.
<b>Wrinkle Free</b> <b>60°C to 30°C</b>	
Fabric	Synthetic fabrics, mixed fibres and easy-care cottons
Note:	For fabrics that crease easily, reduce the final spin cycle speed.
<b>Delicates</b> <b>60°C to cold</b>	
Fabric	For delicate garments made of synthetic fibres, mixed fibres, and rayon Curtains labelled by the manufacturer as machine-washable.
Note:	<ul style="list-style-type: none"> <li>– The fine dust typically found in curtains makes it advisable to use a program with pre-wash.</li> <li>– For curtains that crease easily, reduce the final spin cycle speed or deselect the final spin altogether.</li> </ul>
<b>Woolens</b>  <b>40°C to cold</b>	
Fabric	Textiles made of wool or wool blends, and hand-washable garments
Note:	For fabrics that crease easily, reduce the final spin cycle speed.
<b>Express</b> <b>40°C to cold</b>	
Fabric	Small load of items to be refreshed. (Items suited to the <i>Normal</i> program.)
Note:	If you want to rinse individual items, select this program with the temperature setting <i>cold</i> , and do not add any detergent.

## Program overview

<b>Extra White</b>		<b>90°C to 60°C</b>
Fabric	For white items with special hygienic requests.	
<b>Dress Shirts</b>		<b>60°C to cold</b>
Note:	Pre-treat soiled cuffs and collars as needed. For silk shirts and blouses, use the <i>Delicates</i> program.	
<b>Colours</b>		<b>40°C to cold</b>
Fabric	Mixed loads of garments suitable for the <i>Normal</i> and <i>Wrinkle Free</i> programs.	
Note:	The wash parameters (e.g., water level, wash rhythm and spin speed) are automatically adjusted for each load, to offer the best combination of cleaning and care.	
<b>Darks/Demin</b>		<b>60°C to cold</b>
Fabric	Black and dark items made of cotton, demin or mixed fibres.	
Note:	<ul style="list-style-type: none"> <li>– Wash denim inside-out.</li> <li>– Denim items may run during the first few washes. Take care to wash light and dark items separately.</li> </ul>	
<b>Drain/Spin</b>		
Note:	<ul style="list-style-type: none"> <li>– Drain only: Select <i>No</i> ☉.</li> <li>– Be sure to set the appropriate spin speed.</li> </ul>	

# Extra options

---

The following extras can be added to a program:

	<b>Extended</b>	<b>Sensitive</b>	<b>Heavy Soil</b>	<b>Buzzer</b>
<b>Normal</b>	X	X	X	X
<b>Wrinkle Free</b>	X	X	X	X
<b>Delicates</b>	X		X	X
<b>Woolens</b> 				X
<b>Express</b>		X		X
<b>Extra White</b>	<b>X<sup>1)</sup></b>			X
<b>Dress Shirts</b>	X	X		X
<b>Colours</b>				X
<b>Darks/Demin</b>	X		X	X

**X<sup>1)</sup>** = Extended' is selected and **cannot** be deselected.

# Garment care label symbols

## Washing

The number printed on the washtub symbol indicates the maximum wash temperature for the garment.

	normal agitation
	normal agitation
	reduced agitation
	Hand wash
	Do not wash

## Examples for program selection

Program	Care symbol
Normal	
Wrinkle Free	
Delicates	
Woolens	
Express	
Extra White	
Colours	

## Drying

The dots indicate the temperature

	Normal temperature
	Low temperature
	Do not tumble dry

## Ironing

The dots indicate the ironing temperature

	approx. 200°C
	approx. 150°C
	approx. 110°C
	Do not iron



















## Professional cleaning

	Dry clean only The letters indicate the solvent to be used.
	Professional wet clean only
	Do not dry clean

## Bleaching

	Any oxidizing bleaching agent can be used.
	Use only oxygen-based or non-chlorine bleaches.
	Do not bleach

## Program sequence

	Main wash		Rinse		Spin	
	Water level	Wash rhythm	Water level	Rinses	Interim spin	Final spin
Normal		Ⓐ		2-3 <sup>1)</sup>	✓	✓
Wrinkle Free		Ⓒ		2-3 <sup>2)</sup>	✓	✓
Delicates		Ⓓ		3	–	✓
Woolens		Ⓔ		2	✓	✓
Express		Ⓑ		2-3 <sup>2)</sup>	✓	✓
Extra White		Ⓐ		2-3 <sup>1)</sup>	✓	✓
Dress Shirts		Ⓒ		2	–	✓
Colours		ⒶⒷⒸ		2-3 <sup>2)</sup>	✓	✓
Darks/Demin		Ⓒ		3	✓	✓
Drain/Spin	–	–	–	–	–	✓

 = low water level

 = medium water level

 = high water level

Ⓐ = Intensive rhythm

Ⓑ = Normal rhythm

Ⓒ = Gentle rhythm

Ⓓ = Sensitive rhythm

Ⓔ = Handwash speed

See the next page for program sequence details.



The washer is equipped with fully electronic controls and load recognition. It automatically determines how much water is needed, based on the size and absorbency of the load. This means that program sequences and times can vary.

The program sequences listed here are based on the basic program, with a maximum load. Extra options have not been taken into account.

At any time during a program, you can check the display to see which step has been reached.

## **Special features in the program sequences:**

### Anti-crease:

To help prevent wrinkles, the washer drum will continue to turn at intervals for up to 30 minutes after program completion. Exceptions: In the *Woolens* program, there is no anti-crease feature.

The washer can be opened at any time.

#### 1) A third rinse cycle will occur if:

- there is heavy sudsing in the drum
- the final spin speed is less than 700 RPM
- *No* ☉ has been selected.

#### 2) A third rinse cycle will occur if:

- No* ☉ has been selected.

# Changing a program sequence

---

## Canceling a program

You can cancel a program at any time after it has started.

- Press the *Start/Stop* button.

### Cancel program

- Press the flashing *Start/Stop* button again.

The washer will pump away all the water in the drum.

If you wish to remove the laundry:

- Press the *Door* button.

If you wish to select a different program:

- Use the  button to switch the washer off.
- Switch the washer back on.
- Check that there is still detergent in the dispensing drawer. Add more as needed.
- Select and start a new program.

## Interrupting a program

- Use the  button to switch the washer off.

To continue with the same program:

- Use the  button to switch the washer back on.

## Changing a program

### Program

Once a program has started, a different program cannot be selected.

### Temperature

This setting can be changed within the first five minutes.

- Press the *Temperature* button.

### Spin speed

This setting can be changed up until the start of the final spin cycle.

- Press the *Spin speed* button.

### Extra options

Within the first five minutes of a program you can select or de-select the extras *Sensitive*.

However, if the safety lock is activated, a program can neither be changed nor cancelled.

# Changing a program sequence

## Loading or removing laundry

- Press the *Door* button until the front door opens.
- Load or unload the laundry.
- Close the door.

The program automatically proceeds.

### Please note:

Once a program has started, the washer cannot detect changes to the size of the load.

Therefore, if laundry is added or removed, the washer will assume the maximum load.

The indicated program time may be extended.

### **The door will not open if:**

- the suds are hotter than **55°C**.
- the water level exceeds a certain limit.
- the program step *Spin* has been reached.

If you press the *Door* button during one of the above situations, the following message will appear in the display:

🔒 Door locked

## Childproof lock

The childproof lock prevents the front door from being opened and programs from being interrupted.

### **Childproof feature ON**

- Once a program has started, press and hold the *Start/Stop* button

Stop or in 3 sec. 🔒

- Hold down the *Start/Stop* button until the time has elapsed and the following appears in the display:

Locked 🔒

The childproof feature is now activated and will switch off automatically once the program has finished.

### **Childproof feature OFF**

- Once a program has started, press and hold the *Start/Stop* button

Unlock in 3 sec. 🔓

- Hold down the *Start/Stop* button until the time has elapsed and the following appears in the display:

Unlocked 🔓

# Detergent

---

## Selecting the right detergent

You can use any detergent designed for automatic washing machines. Consult the package for dosages and instructions.

	<b>Universal</b>	<b>Colour</b>	<b>Delicates</b>
Normal	X	X	
Wrinkle Free	X	X	
Delicates			X
Woolens	Liquid detergent especially for woollens		
Express	X	X	
Extra White	X <sup>2)</sup>		
Dress Shirts	X	X	
Colours	X	X	
Darks/Demin		X <sup>1)</sup>	

1) liquid detergent only

2) powdered detergent only

## The right amount to dispense will depend on the following:

- How soiled the laundry is
  - lightly soiled  
No visible dirt or stains. Possibly slight body odour.
  - moderately soiled  
Visibly dirty and/or just a few light stains.
  - heavily soiled  
Visibly dirty and stained, with dried-on soiling.
- The size of the load
- The water hardness  
If you do not know the water hardness level in your area, contact your local water utility.

## Water hardness levels

Range	Total hardness in ppm	Total hardness in grains/gallon US
soft (I)	0 - 130	0 - 8,4
medium (II)	130 - 250	8,4 - 14
hard to very hard (III)	more than 250	more than 14

## Water softener

If your water is in class II or III, you can add a water softener to help cut down on the use of detergent. Consult the package for dosing. First add the detergent, then add the water softener.

In this case, you can dose the detergent as you would for class I.

## Washing with several components

If you are using several different products in the wash (e.g., special application detergents), Miele recommends loading the products in the following order into compartment **III**:

1. Detergent
2. Water softener
3. Stain remover

This will help the products flow smoothly into the wash drum.

# Detergent

## Fabric softener, fabric shaper, and liquid starch

### Starch

can be used to give body and crispness to laundered items.

### Fabric shapers

are synthetic starches and give an even stiffer hold.

### Fabric softeners

make garments soft to handle and help reduce static cling from the tumble dryer.

## Automatic dispensing of fabric softener, fabric shaper, or liquid starch

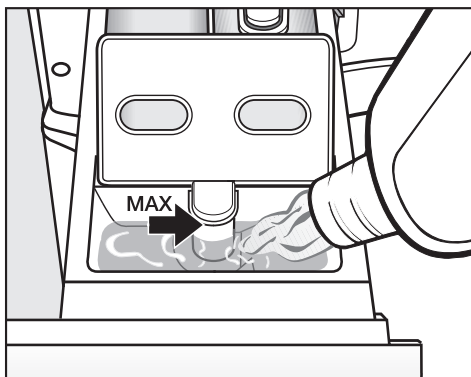

- Load the fabric softener, shaper, or starch into compartment ☼. **Do not exceed the maximum fill line.**

The product will be dispensed automatically during the final rinse cycle. At the end of the wash program, there will be a small amount of water left in compartment ☼.

If starch is used frequently, be sure to thoroughly clean the dispenser compartment, especially the siphon.

## Dyes and dye removers

- **Never** use dye removers in this washer.
- Dyes intended for use in household washing machines may be used. However, please note that the salt used during the dyeing process can cause corrosion to the stainless steel. Closely follow the dye manufacturer's instructions.

### Cleaning the drum

Washing at low temperatures and/or with liquid detergents can allow germs and odours to form inside the appliance. At least once a month, to clean the drum and prevent the formation of odours, run a wash program at 60°C or above, using powdered detergent.

### Cleaning the housing and control panel

 Always unplug the appliance before cleaning.

 NEVER hose down the washer.

- Use a mild cleanser or soapy water to clean the housing and panel, then dry with a soft cloth.
- Use a special stainless steel cleaning product to clean the drum.

 Do NOT use solvent-based products, abrasive cleaners, or glass or all-purpose cleaning agents. They can damage the plastic surfaces and other components.

### Cleaning the dispenser drawer

Regularly remove any detergent residue.

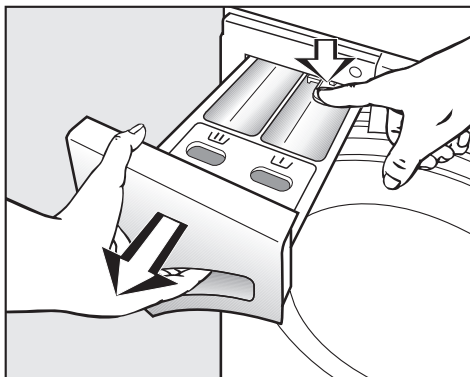

- Pull the detergent drawer out until it stops, press down the release catch, and remove the drawer from the washer.
- Clean the drawer with warm water.

# Cleaning and care

## Cleaning the siphon and softener channel

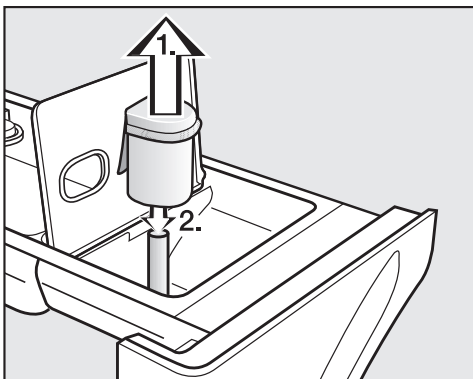

1. Pull the siphon out of the compartment  and rinse under warm running water. Clean the siphon tube the same way.
2. Replace the siphon.

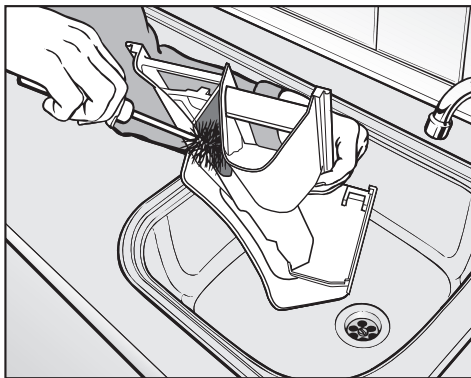

- Clean the fabric softener channel with warm water and a brush.

If liquid starch is used often, the siphon and fabric softener channel will need to be thoroughly cleaned. Liquid starch can cause a build-up and clogging.

## Cleaning the detergent drawer housing

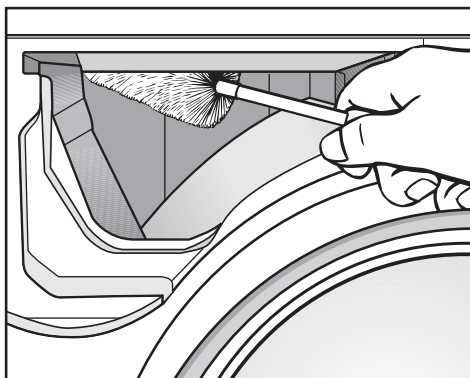

- Use a bottle brush to remove any detergent residue and lime deposits from the jets inside the detergent drawer.



## Cleaning the water inlet filters

The water inlet valves are protected by two filter screens. They need to be checked approx. every 6 months. If there are frequent interruptions to the water network, they may need to be checked more frequently.

### Cleaning the filter in union of the inlet hose

- Close the tap and unscrew the threaded union that connects the free end of the inlet hose to the stopcock.

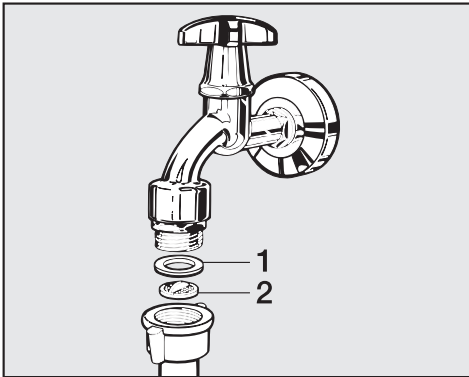

- Remove the rubber seal **1** from the recess.
- Use flat pliers to grasp the plastic filter piece **2**, then remove the filter.
- Clean the filter. Reverse the instructions to re-insert the filter and seal.

### To clean the filter in the water inlet valve

- Use adjustable pliers to carefully loosen the ribbed plastic nut on the inlet valve and unscrew.

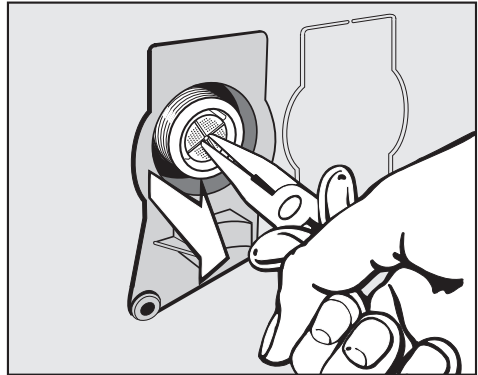

- Use flat pliers to pull the filter out by the fin, and clean it. Reverse the instructions to re-insert and secure the parts.

Both filters **MUST** be re-inserted after cleaning.

# Troubleshooting

---

## What to do if . . .

Many of the faults you may encounter during everyday use can be easily rectified yourself. This helps save time and money, because you won't need to call Customer Service.





The following troubleshooting guide can be used to help address minor problems without a service call. However, please note the following:

 Repairs to electrical appliances should only be carried out by qualified professionals. Work performed by unqualified persons can place the user at considerable risk of harm.

### No wash program will start



<b>Problem</b>	<b>Possible cause</b>	<b>Remedy</b>
<b>The display is dark and the indicator light for the <i>Start/Stop</i> button does not come on.</b>	There is no power to the washer.	Check whether: – the cord is plugged in. – the fuse is in working order.
<b>The display prompts you to enter a pin code.</b>	The pin code feature is active.	Enter and confirm the pin code. De-activate the pin code if you do not wish the prompt to appear the next time the washer is switched on.
<b>The display is dark.</b>	The display automatically dims to save energy (standby).	Press any button. This will bring the display back on.

## Fault messages in the display

Problem	Possible cause	Remedy <sup>①</sup>
<b>The display lights up  and Drain fault flashes.</b>	<ul style="list-style-type: none"> <li>– The water outlet is restricted or blocked.</li> <li>– The drain hose is sitting too high.</li> </ul>	<ul style="list-style-type: none"> <li>– Clean the drain filter and pump.</li> <li>– The max. drain pump height (delivery head) is 1m.</li> </ul>
<b>The display lights up  and Water inlet fault flashes.</b>	The water inlet is blocked or restricted.	Check whether: <ul style="list-style-type: none"> <li>– the stopcock is open enough.</li> <li>– the inlet hose is pinched or bent.</li> <li>– the water pressure is too low.</li> </ul>
<b>The display lights up  and Waterproof fault flashes.</b>	The water protection system was triggered.	Call the service department.
<b>The display lights up  and Technical fault flashes.</b>	There is a fault.	Re-start the program. If the fault message appears again, call Customer Service.
<b>The display flashes Anti-crease Chk detergent</b>	Excessive foam has built up during washing.	Use less detergent next time, and check the recommended doses on the package.

<sup>①</sup> To switch off the fault message: Use the  button to switch the washer off.

# Troubleshooting

General problems		
Problem	Possible cause	Remedy
<b>The washer shakes during spin cycles.</b>	The feet are not leveled.	Even out the feet so the washer is stable, and tighten the nuts.
<b>The washer didn't spin the laundry properly, and it is still wet.</b>	There was an imbalance during the final spin cycle and the spin speed was automatically reduced.	It is best to include a mix of large and small items in the washer, so the laundry will distribute evenly. Re-arrange the laundry and start <i>Spin</i> program.
<b>There pump is making unusual noises.</b>	This is not a fault. Slurping noises are normal when the pump starts and finishes.	
<b>A lot of detergent is left behind in the detergent compartment.</b>	The water pressure is too low.	<ul style="list-style-type: none"> <li>– Clean the water inlet filter.</li> <li>– Consider using the <i>Sensitive</i> option.</li> </ul>
	Powdered detergents used along with water softeners tend to clump.	Clean the detergent compartment and, in the future, first load the detergent into the compartment, followed by the water softener.
<b>Some fabric softener remains behind in the compartment, or there is too much water in the  compartment.</b>	The siphon tube is clogged or not positioned correctly.	Clean the siphon (see "Cleaning and care - Cleaning the dispenser drawer").
<b>A foreign language appears in the display.</b>	A different language has been selected in the "Programmable functions - Language  menu.	Select the language you prefer. Use the flag symbol as a guide.

## Unsatisfactory wash results

Problem	Possible cause	Remedy
<p><b>You used liquid detergent and the laundry isn't clean.</b></p>	<p>Liquid detergents usually do not contain bleaching agents. They may fail to remove fruit, coffee and tea stains..</p>	<ul style="list-style-type: none"> <li>– Use powdered detergent that contains bleach.</li> <li>– Load the detergent into the compartment .</li> <li>– Never load liquid detergent and a stain remover together into the dispenser drawer.</li> </ul>
<p><b>There is a sticky grey residue on the laundry (fat deposits).</b></p>	<p>Not enough detergent was used to break down the grease in heavily soiled laundry.</p>	<ul style="list-style-type: none"> <li>– For heavily soiled laundry, you can add more powdered detergent, or use liquid detergent.</li> <li>– Before washing the next load, run the 60°C wash program with liquid detergent, but no laundry in the machine.</li> </ul>
<p><b>There are white spots that look like powdered detergent on your dark garments.</b></p>	<p>Some powdered detergents contain an insoluble mineral ingredient (zeolites) that acts as a water softener. This can form a deposit on fabrics.</p>	<ul style="list-style-type: none"> <li>– Once the laundry is dry, try using a brush to remove the flecks.</li> <li>– In the future, use detergents without added water softener to wash your dark items. Most liquid detergents do not contain zeolites (water softeners).</li> <li>– Use the <i>Darks</i> program only for these items.cf</li> </ul>

# Troubleshooting

## The loading door cannot be opened with the Door button

Possible cause	Remedy
<b>The washer is not connected and/or switched on.</b>	Insert the three-pin plug into the socket and/or switch the washer on using the  button.
<b>The safety lock has been activated.</b>	Switch off the childproofing as described in the section on "Changing a program sequence" under "Safety lock".
<b>The pin code feature is active.</b>	Switch off the pin code as described in the section on "Programmable functions" under "Pin code".
<b>Power failure</b>	Open the loading door as described in the next section.
<b>The door was not properly closed.</b>	Firmly press the latch side of the loading door, then press the <i>Door</i> button.
<b>There is still water in the drum and the washer cannot drain.</b>	Clean the drain filter and pump, as described in the next section.
To prevent scalding, the door will not open if the suds temperature is higher than 55°C.	

## Opening the loading door (blocked drain outlet and/or power outage)

- Switch the washer off.

Behind the flap that covers the detergent compartment, there is lever to open the access flap.

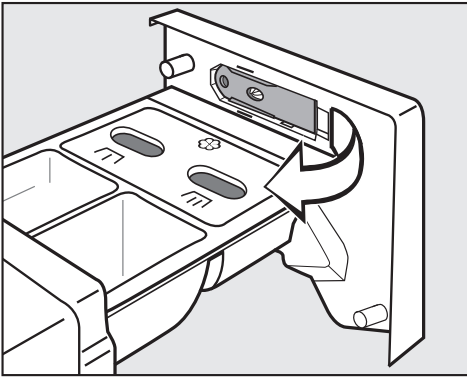

- Pull the lever out.

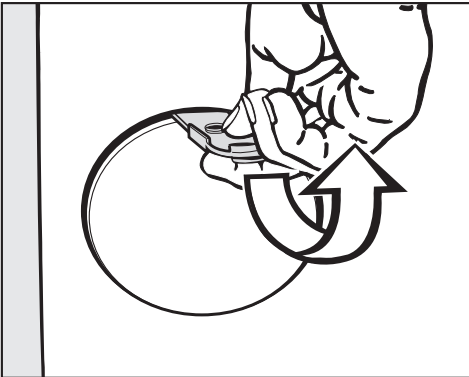

- Use it to open the access flap.

## Blocked drain outlet

If the drain outlet is blocked, **up to 25 l** will be retained inside the washer.

**⚠ Caution:** If laundry has just been washed at a high temperature, water draining out of the machine will still be hot - Beware of scalding!.

## How to drain the washer

- Place a suitable container under the access flap.

Do NOT unscrew or entirely remove the drain filter.

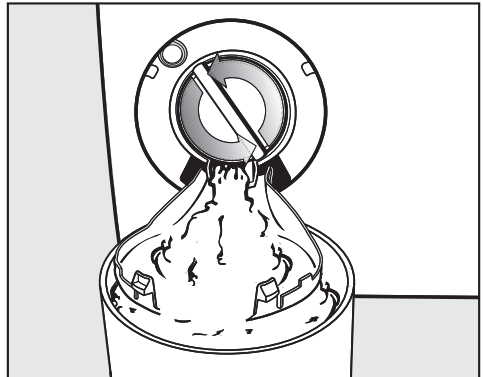

- Instead, loosen the drain filter enough to allow the water to drain out.

To interrupt the flow of water:

- Tighten the drain filter back up again.

# Troubleshooting

Once the flow of water ceases:

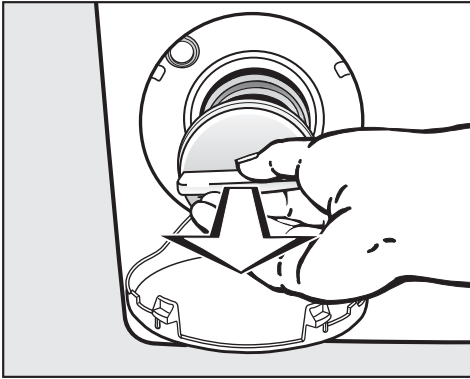

- Pull the drain filter entirely out.
- Thoroughly clean the filter.

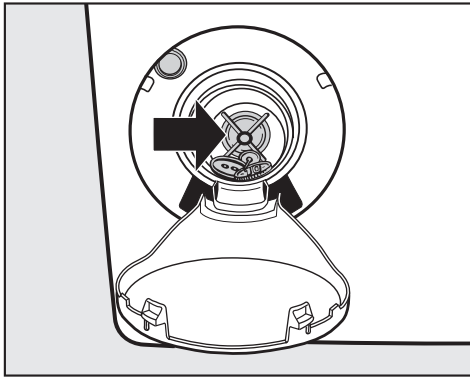

- Turn the pump blade by hand to check that it moves freely, and remove any foreign objects (buttons, coins, etc.) that are causing an obstruction.
- Put the drain filter back in place and tighten it down.

 If the drain filter is not securely tightened, there is a risk of water leakage during operation.

## Opening the loading door

 NEVER reach into the drum until it has completely stopped moving. Reaching into a moving drum carries the risk of serious injury.

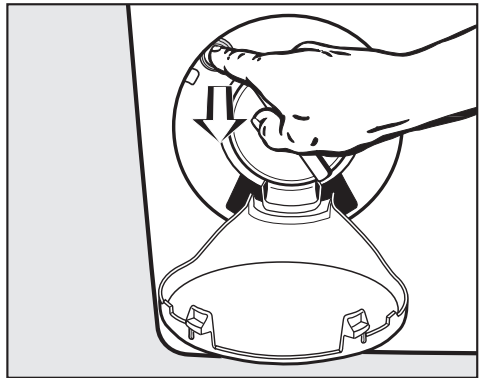

- Pull the emergency release (see illustration). The loading door will open.



## Repairs

For faults you cannot remedy yourself, please contact:

- your Miele dealership or
- the Miele Factory Repair Service.

The telephone number for the Factory Repair Service is listed at the back of these operating instructions.

When contacting Customer Service, you will need to quote the model and serial number of your appliance. This information can be found on the data plate, above the porthole glass when the door is open.

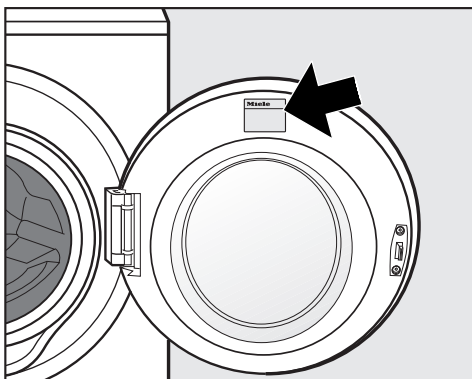

## Program updates (PC)

The PC optical interface is used by Customer Service to transfer program updates (PC = Program Correction).

This information is used to integrate future developments in detergents, fabrics and wash procedures into your appliance.

Miele will give timely notification of Program updates.

## Additional accessories

Optional accessories for this washer are available from your Miele dealer or from Miele Customer Service.

# Installation and connection

## Front view

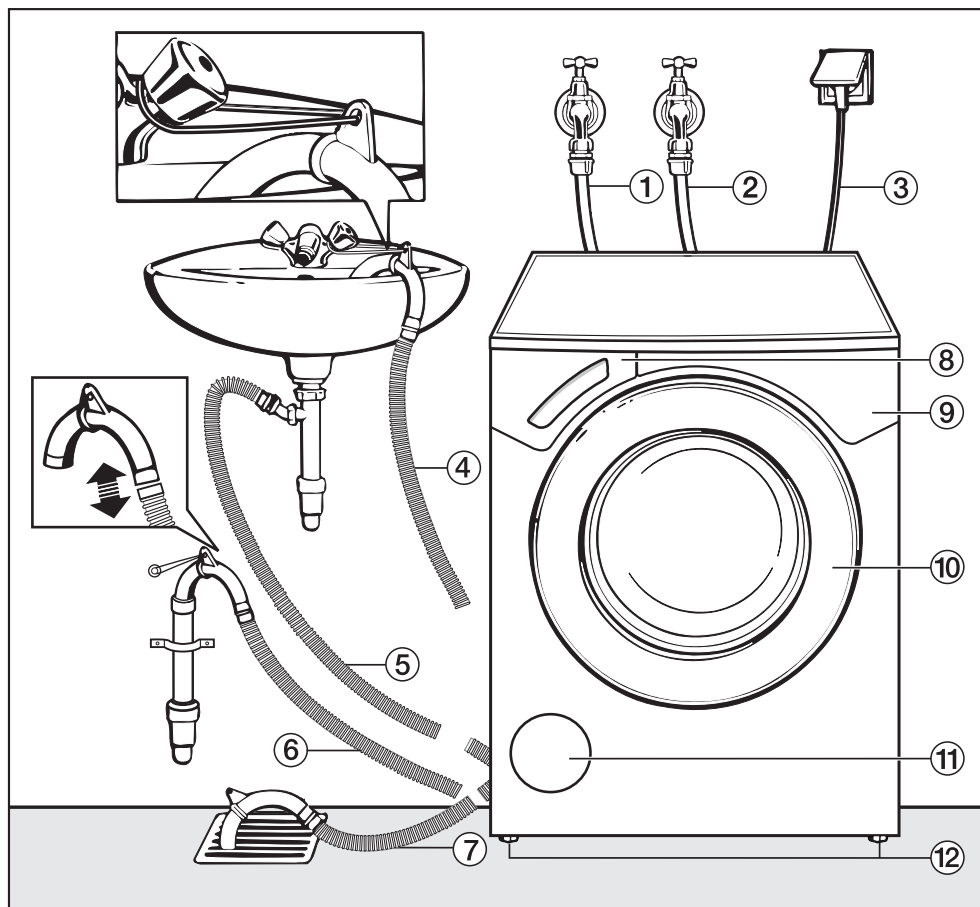

① Inlet hose for hot water

② Inlet hose for tap water (cold)

③ Power cord

④ - ⑦ Drain hose (with detachable swivel elbow)

⑧ Detergent dispenser drawer

⑨ Control panel

⑩ Loading door

⑪ Access to drain filter, drain pump, and emergency door release

⑫ Four height-adjustable feet

## Rear view

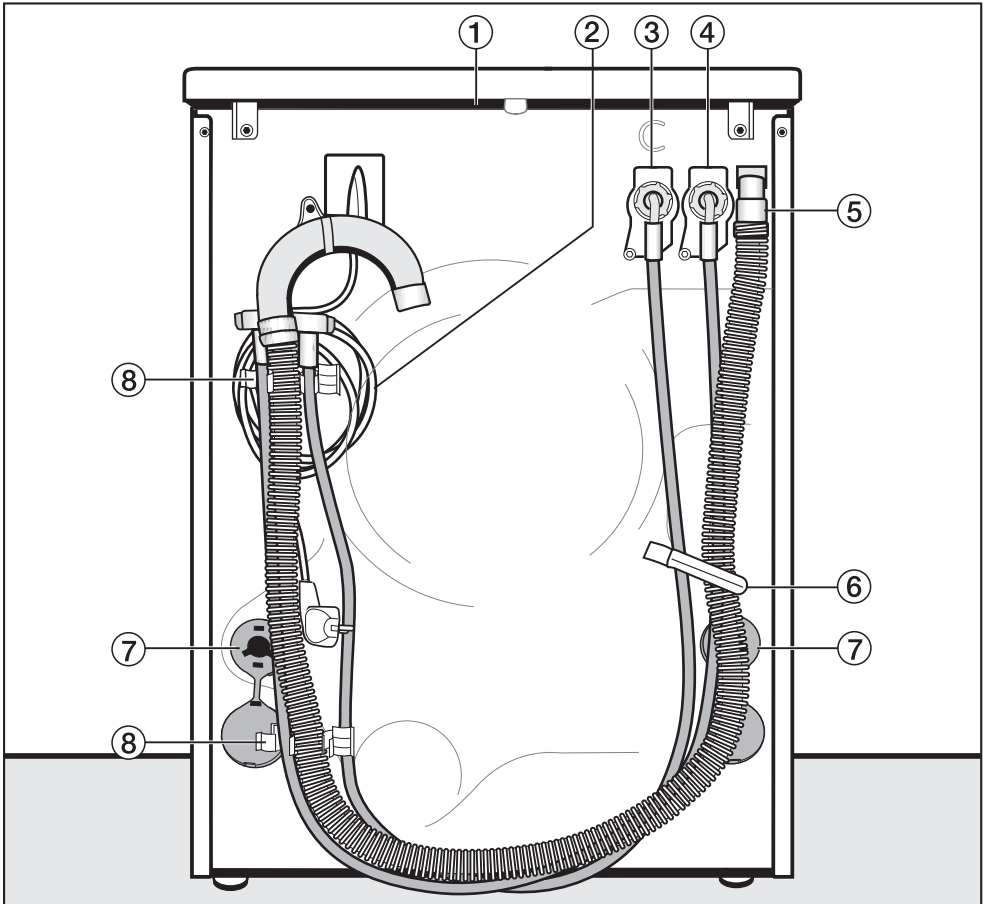

① Protruding lid to grip when moving the washer

② Power cord

③ Inlet hose for tap water (cold)

④ Inlet hose for hot water

⑤ Drain hose

⑥ Transport clip for inlet and drain hoses

⑦ Safety cap for transit bars

⑧ Transport clip for inlet and drain hoses and for storing transit bars when not in use.

# Installation and connection

## Installation surface

A concrete floor is the most suitable installation surface for a washing machine, being far less prone to vibration during the spin cycle than wooden floorboards or a carpeted surface.

Please note:

- The machine must be level and securely positioned.
- To avoid vibrations during spinning, the machine should not be installed on soft floor coverings.

If installing on a wooden joist floor:

- We recommend a plywood base (at least 59x52x3 cm). The base should span several joists and be bolted to the joists and not only to the floorboards. Check for the presence of pipes and cables first.

If possible, install the machine in a corner, as this is usually the most stable part of the floor.

⚠ If the machine is installed on a raised plinth, it **has to be secured** against slippage during spin using retaining clips (available from the Miele Spare Parts Dept). Otherwise there is the danger of the machine moving about and falling off the plinth.

## Transporting the washing machine to its installation site

To manoeuvre the machine out of its packing case to its installation site hold it by the edge of the lid where it protrudes to the rear of the washing machine as well as by the front feet.

⚠ Ensure that the machine feet and the floor are dry to prevent the machine from slipping during the spin cycle.

## Removing the transit bars

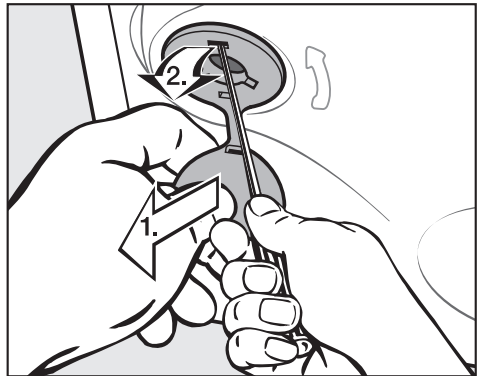

- To remove the left and right covers
  1. Pull on the attached stopper,
  2. then use a screwdriver to release the catch at the top.

## Installation and connection

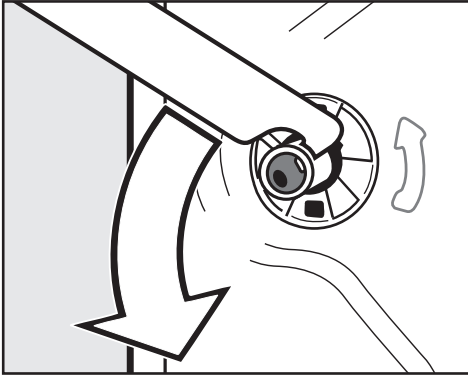

- Using the spanner supplied, turn the left-hand transit bar 90°, then

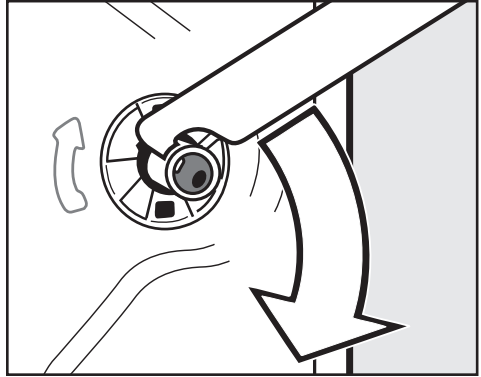

- Turn the right-hand transit bar 90°, then

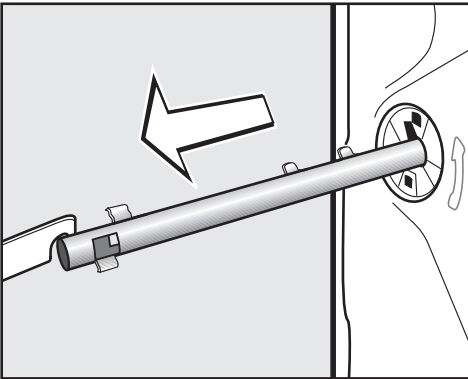

- withdraw the transit bar.

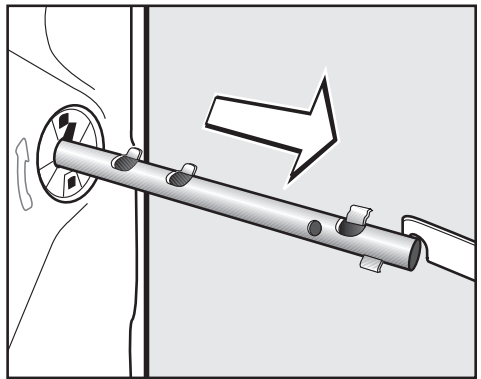

- withdraw the transit bar.

## Installation and connection

 To avoid the risk of injury the holes for the transit bars must be covered after the transit bars have been removed.

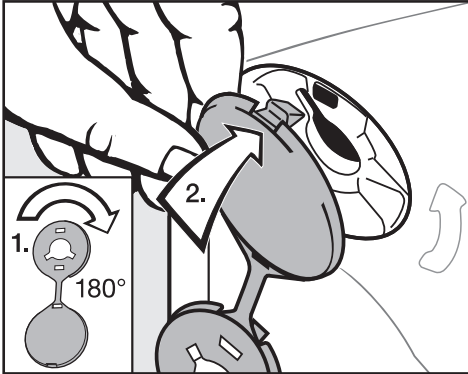

- Plug the holes with the plastic caps as illustrated.

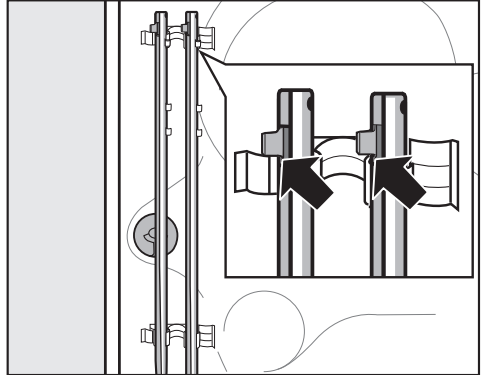

- Secure the transit bars to the back of the washing machine. Make sure that the top catch is located above the holder.

 The machine must not be moved without the transit bars in place. Store them as shown or keep them in a safe place for future use. They must be re-fitted if the machine is to be moved again (e.g. when moving house).

### Re-fitting the transit bars

Re-fitting is carried out by reversing the procedure.

## Levelling the machine

To ensure safe and proper operation, the washer must stand perfectly level on all four feet.

Improper footing may increase water and power consumption, and may cause the washer to wander across the floor.

## Screw out and adjust the feet

Use the four adjustable feet to level the washer. The washer is delivered with all four feet in the shortest (screwed in) position.

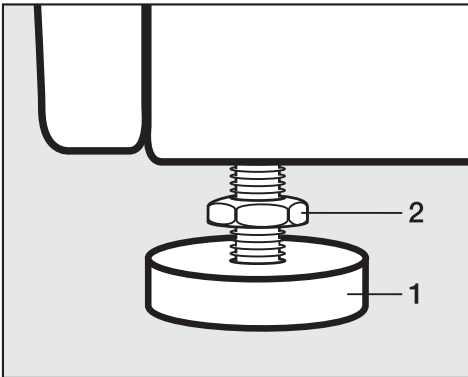

- Use the combination wrench provided to turn the counter nut **2** counterclockwise. Then turn the counter nut **2** together with the foot **1** to unscrew.

- Use a level to check that the washer is standing square.

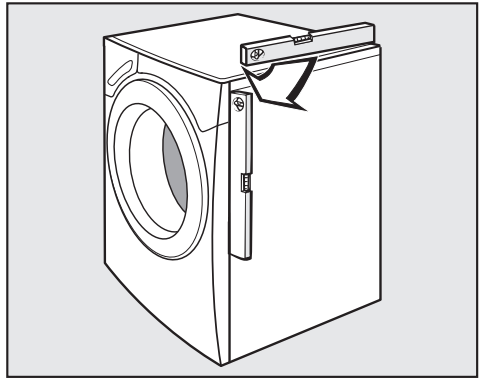

- Hold the foot **1** securely with a pipe wrench. Now use the combination wrench to screw the counter nut **2** firmly back up against the housing.

 All four counter nuts must be tightened firmly up against the housing. Be sure to also check this on the feet that did not require levelling. Otherwise, the washer may wander about.

# Installation and connection

## Installing under a countertop

 The washer lid must NOT be removed.

Provided the workspace is high enough, the washer can be pushed under a countertop with the lid in place.

## Washer-dryer stack

The washer can be stacked with a Miele tumble dryer. A stacking kit will "WTV 414", be required and can be obtained through your Miele dealer or Miele Customer Service.

### Please note:

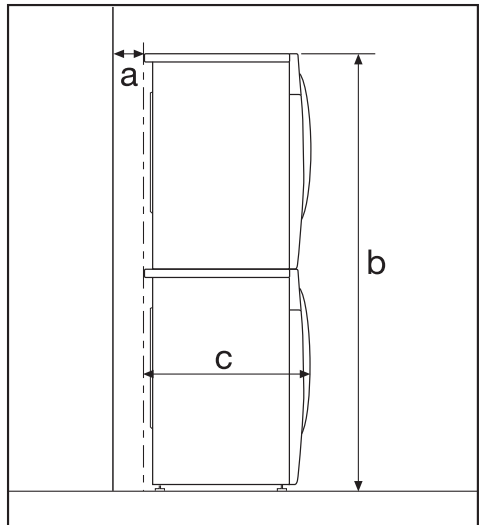

- a** Safety clearance to wall:  
at least 2 cm
- b** Height:  
Stacking kit with pull-out shelf:  
approx. 172 cm
- c** Depth of the washer-dryer stack:  
approx. 65 cm

Stacked units may not be installed on pedestals.



## The Miele water protection system

The Miele water protection system protects the washer from water damage.

The system consists of three main components:

- 1) the inlet hose
- 2) the washer electronics and housing
- 3) the drain hose

### 1) The inlet hose

- Hose burst protection

The inlet hose can withstand pressure of more than 7000 kPa.

### 2) The electronics and housing

- Sump

Any leaking water is collected in a sump in the base of the washer. A float then switches off the inlet valves, preventing any additional water inflow, and any water in the suds container is pumped away.

- Overflow protection

This feature helps prevent the washer from taking in too much water. If the water exceeds a certain level, the drain pump starts and pumps away the water.

### 3) The drain hose

The drain hose is equipped with a ventilation system that prevents the washer from being emptied accidentally.

## Connecting to the water supply

The washer is designed to comply with applicable CSA standards, for connection to a tap water line. It does not require a non-return valve.

The flow pressure must be between 100 kPa and 1000 kPa. If the pressure is above 1000 kPa, a pressure-reducing valve **MUST** be installed.

Two stopcocks with  $\frac{3}{4}$ " thread are required for connecting to the water supply. If these are not available, you will need to have a qualified plumber fit the washer to the water supply.

 The screw fittings are under pressure from the water line. To check that the connections are watertight, slowly open the taps. Correct the placement of the washer and union as needed.

## Maintenance and care

If the hose ever needs to be replaced, use only a genuine Miele hose - it is tested to withstand pressure of at least 7000 kPa.

In order to protect the water inlet valve, the two dirt filter screens (one in the open end of the inlet hose, the other in the inlet point in the washer) should not be removed.

## Optional extension hose

Longer hoses 2.5 or 4.0 m in length are available from your Miele dealer or Miele Customer Service.

# Installation and connection

---

This washer uses hot and cold household water.

The washer must always be connected to a tap water line (cold water, inlet hose with blue tag).

## Tap water line (cold water)

The tap water connection is established using the inlet hose with the blue marking.

If the washer is connected to this line only, the appliance will need to be re-programmed to cold water fill only.

Please contact your Miele dealer or Miele Customer Service for reprogramming instructions.

The second unused inlet hose, with the red tag, will be attached to the rear of the washer after re-programming.

## Hot water connection

The hot water connection is established using the inlet hose with the red marking.

## Tips for the hot water connection

- The hot water temperature at the stopcock must not exceed 60°C, and the ideal temperature is 55°C.
- If the hot water inlet is closed, the washer will automatically switch over to tap water mode after a period of time. This safety feature is not intended for long-term use. The washer will continue to wash in hot water mode, which can lead to a poor wash result.

## Drainage system

The appliance drains through a pump with a 1m delivery head. For the water to drain freely, the hose must be free of kinks. The swivel elbow at the end of the hose can be turned in either direction, or removed as needed with a sharp twist and pull.

If required, the hose can be extended to a length of 5m. The necessary parts can be ordered through your Miele dealer or Miele Customer Service.

For delivery heads over 1m (up to a max. of 1.8 m), contact your Miele Customer Service for a replacement pump and with a part # 1053992.

### Drain hose connection:

1. Hang directly into a washbasin or sink:

Please note:

- Secure the hose over the edge so that it will not slip.
  - Make sure that the water can drain away freely without hindrance. Otherwise, the water could overflow or be sucked back up into the washing machine.
2. Connect securely to a plastic drain pipe with a rubber sleeve (not-return valve not required).
  3. Connect securely to a floor gully.
  4. Attach to a washbasin with a plastic fitting.

# Installation and connection

---

## Electrical connection

### GROUNDING INSTRUCTIONS

This appliance must be grounded. In the event of a malfunction or breakdown, grounding will reduce the risk of electric shock by providing a path of least resistance for electric current. This appliance is equipped with a cord having an equipment-grounding conductor and a grounding plug. The plug must be plugged into an appropriate outlet that is properly installed and grounded in accordance with all local codes and ordinances.

**WARNING** - Improper connection of the equipment-grounding conductor can result in a risk of electric shock. Check with a qualified electrician or service representative if you are in doubt as to whether the appliance is properly grounded.

Do not modify the plug provided with the appliance; if it will not fit the outlet, have a proper outlet installed by a qualified electrician.

## ELECTRICAL INSTRUCTIONS

This installation should be performed by an experienced and qualified technician, in accordance with local codes and regulations

The washing machine is supplied with a 5'3" long, 4 wire cord, ending in a NEMA 14-30 P plug, ready for connection to a 120/208-240 V, 30 A, 60 Hz, AC power supply.

### "EASY INSTALLATION KIT"

If a dedicated 4 wire, 120/208-240 V, 30 Amp line is not available for this appliance, an optional "Easy Installation Kit" will allow you to connect to a 240 V, 30 Amp line.

This dual receptacle, wall mounted connection box can **ONLY** be used for connecting the W 1753 Miele clothes washer and the T 7634 or T 7644 C clothes dryer to an existing 30 Amp (NEMA 14-30 R) outlet.

Miele recommends to wall mount the easy installation kit adjacent to existing electric outlets.

For more information on the "Easy Installation Kit", or if you have questions concerning the electrical connection, please contact:

1-800-565-6435  
service@miele.ca

## Technical data

Height	850 mm
Width	595 mm
Depth	634 mm
Depth with door open	1074 mm
Height for building under	850 mm
Width for building under	600 mm
Weight	99 kg
Voltage	see data plate
Connected load (watts)	see data plate
Fuse rating	see data plate
Consumption data	see section on "Consumption data"
Min. water flow pressure	100 kPa (1 bar)
Max. water flow pressure	1000 kPa (10 bar)
Inlet hose length	1.60 m
Drain hose length	1.50 m
Length of power cord	1.60 m
Max. drain pump height	1.00 m
Max. drain pump length	5.00 m
LED (light emitting diodes)	Class 1
Test certifications granted	see data plate

# Programmable functions for changing default settings

You can use the programmable functions to adjust the electronics to suit changing requirements. Programmable functions can be changed at any time.

## To access programmable functions

Use the *Start/Stop* button and the program selector to access the programmable functions. This second function for the button and selector is not indicated on the panel.

Before you begin, check that:

- The washer is switched off.
  - The door is properly closed.
- 1 Press and hold the *Start/Stop* button during steps 2 to 3.

- 2 Press the  button in.

- 3 As soon as the display shows . . .



Language  ...

. . . you can release the *Start/Stop* button.

You now have access to the programmable functions.

## To select a programmable function

- 3 Turn the program selector until the desired programmable function appears in the display.
- 5 To change a displayed programmable function, press the *Start/Stop* button.

## To change a programmable function

Turn the program selector to see the various options available for a programmable function.

The currently set option is marked with a check .

- 6 Turn the program selector until the desired option appears.
- 7 To activate the option, press the *Start/Stop* button.

## To exit a programmable function

- 8 Turn the program selector until *Back*  appears in the display.
- 9 Press the *Start/Stop* button.

## Language

The display can be set to appear in one of several different languages.

The flag  after the word *Language* is a cue for the user, in case the menu item appears in an unfamiliar language.

The selected language will be stored in the memory.

# Programmable functions

---

## Gentle wash

Activating the Gentle wash feature reduces the drum action. It is suitable for gently washing mildly soiled items.

This option can be activated within the programs for *Normal* and *Wrinkle Free*.

The factory setting for Gentle wash is Off.

## Suds cooldown

With this feature, additional water flows into the washer at the end of the main wash, to cool down the suds.

The cooldown feature kicks in with the 90°C and 75°C programs.

Cooldown should be activated if:

- the drain hose is hooked over a basin or sink - this will help prevent scalding.
- the drain pipes in the building do not comply with DIN 1986.

The factory setting for the Cooldown option is Off.



## Pin code

You can use a pin code to lock the electronics. This feature protects your washer against unauthorized use.

Once the pin code is activated, you will need to enter it whenever you wish to operate the washer.

Pin code ...

- Press the *Start/Stop* button.

### To activate the pin code

Activate

- Press the *Start/Stop* button.

You will now be prompted to enter the pin code.

### Enter the code

The code is **125** and cannot be changed.

0 \_ \_

- Turn the program knob until the first digit appears.
- Press the *Start/Stop* button to confirm the first digit.
- Repeat this process until all three digits have been entered.

1 2 5

- Press the *Start/Stop* button.

The following appears in the display for confirmation:

Code activated

Once the washer has switched off, it cannot be used again unless the code is entered.

### To operate the washer with the pin code

When the appliance is switched on, you will be prompted to enter the pin code.

- Enter the code as explained above, and confirm.

The washer is now unlocked for use.

### To de-activate the pin code

Switch on the programming functions as described.

- ③ As soon as the display shows . . .

0 \_ \_

. . . you can release the *Start/Stop* button.

- Now enter the pin code and press the *Start/Stop* button.
- Select the *pin code* and confirm *de-activate*.

# Programmable functions

---

## Temperature unit

You can choose whether temperatures will be displayed in °C/*Celsius* or in °F/*Fahrenheit*.

The factory setting is °C/*Celsius*.

## Buzzer

When the buzzer feature is activated, a signal will be heard when the program ends or when Rinse hold is reached.

You can select one of two buzzer volumes:

### Normal

(Factory setting)

The buzzer sounds at *normal* volume whenever a program ends or when Rinse hold is reached.

### Loud

The buzzer sounds at *maximum* volume whenever a program ends or when Rinse hold is reached.

## Keypad tone

There will be a beep whenever a button is pressed.

The factory setting for the keypad tone is Off.

## Brightness

There are 10 different settings for the display brightness.

The bar diagram indicates which level is selected.

The factory setting for brightness is 5.

The brightness changes as soon as you choose a different setting.

## Contrast

There are 10 different settings for the display contrast.

The bar diagram indicates which level is selected.

The factory setting for contrast is 5.

The contrast changes as soon as you select the preferred level.

## Standby display

To save energy, the display goes out and the *Start/Stop* button will start flashing slowly.

The display will always go out:

- if no program is selected within 10 minutes of switching on the machine.
- 10 minutes after the end of a program.

Press any button to bring the display back on.

You can also set the display to fade out or remain visible while a program is running.

### On

The standby function is activated. The display will fade out 10 minutes after the program has started.

### Not in current Progr.

(Factory setting)

The standby function is not activated. The display remains visible while a program is running.

## Memory

Whenever a program starts, the washing machine stores the most recently selected settings (program, temperature, spin speed/RPM and any extra options).

The next time the machine is switched on, the washer displays this stored information.

The factory setting for the memory function is Off.

## Anti-crease

The crease-free setting is designed to help prevent wrinkles from forming if the laundry is not immediately removed at the end of a program.

The washer drum will continue to rotate at intervals for up to 30 minutes after program completion.

You can open the washer at any time to remove the laundry.

### On

(Factory setting)

The anti-crease feature is activated.

### Off

The anti-crease feature is off.



**Canada**  
**Importer**  
**Miele Limited**

**Headquarters and Miele Centre**

161 Four Valley Drive  
Vaughan, ON L4K 4V8  
[www.miele.ca](http://www.miele.ca)

**Customer Care Centre**

Phone: 800-565-6435  
[customercare@miele.ca](mailto:customercare@miele.ca)

**Germany**  
**Manufacturer**

Miele & Cie. KG  
Carl-Miele-Straße 29  
33332 Gütersloh