



Operating and installation instructions Cooker and oven



To avoid the risk of accidents or damage to the appliance it is **imperative** that you read these instructions before installing the appliance and using it for the first time.

Contents

Warnings and safety instructions	5
Caring for the environment	15
Guide to the cooker	16
Guide to the oven	17
Oven controls	18
Function selector	19
Temperature selector.....	19
Clock/timer	19
Display.....	19
Sensor controls	19
Features	20
Model designation	20
Data plate	20
Items supplied	20
Standard and optional accessories.....	20
Side runners	20
Baking tray, universal tray and rack with non-tip safety notches.....	21
FlexiClip runners HFC 70-C	21
Oven safety features	26
Oven system lock 	26
Cooling fan	26
Vented oven door	26
PerfectClean treated surfaces	27
Catalytic enamelled surfaces	27
Cooktop controls.....	27
Initial commissioning	28
Before using for the first time.....	28
Setting the time of day for the first time.....	28
Heating up the oven for the first time.....	29
Overview of functions	30
Energy saving tips	31
Using the oven	32
Simple operation	32
Cooling fan	32
Preheating the oven	33

Clock/timer	34
Display	34
Symbols on the display	34
Buttons	34
Setting the time	35
Time display	35
At the end of the duration.....	35
Using the minute minder 	36
Setting the minute minder	36
Changing the minute minder duration.....	37
Deleting the minute minder duration	37
Switching cooking programs on and off automatically	38
Setting the cooking duration	38
At the end of the cooking duration:.....	39
Setting a cooking duration and end of cooking duration	39
Changing the cooking duration	40
Deleting a cooking duration	40
Deleting the end of cooking duration	41
Changing the time of day	41
Changing settings	42
Baking	44
Notes on using the baking charts	45
Baking charts	46
Creamed mixture.....	46
Rubbed-in mixture.....	48
Yeast and quark doughs	50
Sponge mix	52
Choux pastry, puff pastry, meringue.....	53
Roasting	54
Notes on using the roasting charts	54
Roasting charts	55
Beef, veal.....	55
Pork	56
Lamb, venison.....	56
Poultry, fish.....	57
Slow Roasting	58
Broiling	60
Notes on using the broiling chart	61
Broiling chart	62

Contents

Further applications	63
Defrost.....	63
Heating dishes.....	63
Eco-Convection.....	64
Frozen food/Ready meals.....	65
Drying/dehydrating.....	66
Canning	67
Cleaning and care	68
Unsuitable cleaning agents	68
Tips.....	68
Normal soiling.....	69
Cleaning the seal.....	69
Stubborn soiling (excluding the FlexiClip runners).....	69
Stubborn soiling on the FlexiClip runners	69
Cleaning catalytic enamelled panels.....	70
Removing soiling caused by spices, sugar and similar deposits.....	70
Removing oil and grease.....	70
Removing the door.....	71
Reinstalling the door	72
Removing the side runners with FlexiClip runners	73
Removing the back panel.....	73
Lowering the browning/broiling element	74
Problem solving guide	75
Service and warranty	78
Installation	79
Installation diagrams	79
Appliance and cut-out dimensions	79
Dimensions of oven front	81
Installing the cooker	82
Installing the oven	83
Electrical connection	84

Warnings and safety instructions

▶ These IMPORTANT SAFETY INSTRUCTIONS apply to Ovens and Combinations oven/cooktop. They are referred to as ovens in the general text throughout this manual.

▶ IMPORTANT SAFETY INSTRUCTIONS for Cooktop, please see separate “Operating and Installation Instructions Ceramic cooktops”.

When using the appliance, follow basic safety precautions, including the following:

Read all instructions before installation and use of the oven to prevent accidents and machine damage.

This appliance complies with current safety requirements. Improper use of the appliance can lead to personal injury and material damage.

Read all instructions before installing or using the oven for the first time. Only use the appliance for its intended purpose.

Keep these operating instructions in a safe place and pass them on to any future user.

Warnings and safety instructions

Appropriate use

- ▶ This oven is intended for domestic use and use in other similar environments.
- ▶ The oven is not intended for outdoor use.
- ▶ The oven is intended for domestic use only to bake, roast, broil, cook, defrost, can and dry food. All other types of use are not permitted.
- ▶ Risk of Fire! Do not use this oven to store or dry flammable materials.
- ▶ This oven can only be used by people with reduced physical, sensory or mental capabilities or lack of experience and knowledge if they are supervised whilst using it.
- ▶ This oven is supplied with a special lamp to cope with particular conditions (e.g. temperature, moisture, chemical resistance, abrasion resistance and vibration). This special lamp must only be used for the purpose for which it is intended. It is not suitable for room lighting.

Safety with children

- ▶ Activate the system lock to ensure that children cannot switch on the oven inadvertently.
- ▶ Children should not be left alone or unattended in an area where an oven is in use. Never allow children to operate, sit or stand on any part of the oven. **Caution:** Do not store items of interest to children in cabinets above an oven. Children climbing on the oven to reach these items could be injured.
- ▶ Burn Hazard - Do not allow children to use the oven. Failure to do so can result in severe burns or serious injury.
- ▶ Children under eight years of age must be kept away from the appliance unless they are constantly supervised.

Warnings and safety instructions

- ▶ Children aged eight and older may only use the oven without supervision if they have been shown how to use it in a safe manner. Children must be able to recognize and understand the possible consequences of incorrect operation.
- ▶ Children must not be allowed to clean or maintain the appliance unsupervised.
- ▶ Danger of suffocation. While playing, children may become entangled in packaging material (such as plastic wrapping) or pull it over their head with the risk of suffocation. Keep packaging material away from children.
- ▶ Danger of burning! Children's skin is far more sensitive to high temperatures than that of adults. External parts of the oven such as the door glass, control panel and the vent become quite hot. Do not let children touch the oven when it is in operation.
- ▶ Danger of burning! The cooking zones on cookers get hot when in use. Turn all handles to the side over the countertop so that children cannot pull pots and pans down and burn themselves.
- ▶ Danger of injury. Never allow children to hang or lean on any part of the appliance.

Technical safety

- ▶ This appliance must be installed and connected in compliance with the installation instructions.
- ▶ Installation, maintenance and repair work should only be performed by a Miele authorized service technician. Installation, maintenance and repair work by unqualified persons can cause considerable danger to users.
- ▶ Damage to the oven can compromise your safety. Check the appliance for visible signs of damage. Do not use a damaged oven.

Warnings and safety instructions

► Temporary or permanent operation on an autonomous power supply system or a power supply system that is not synchronized with the grid power supply (e.g., island networks, back-up systems) is possible. A prerequisite for operation is that the power supply system complies with the specifications of EN 50160 or an equivalent local standard.

The function and operation of the protective measures provided in the domestic electrical installation and in this Miele product must also be maintained in isolated operation or in operation that is not synchronized with the grid power supply, or these measures must be replaced by equivalent measures in the installation. As described, for example, in the current version of VDE-AR-E 2510-2 or an equivalent local standard.

► To guarantee the electrical safety of this appliance, continuity must exist between the appliance and an effective grounding system. This appliance must be grounded. Connect only to properly grounded outlet. See “Electrical connection - GROUNDING INSTRUCTIONS”. It is imperative that this basic safety requirement be met. If there is any doubt, have the electrical system of the house checked by a qualified electrician.

► The connection data (voltage and frequency) on the data plate of the oven must match the domestic power supply in order to avoid the risk of damage to the oven.

Compare the data before connecting the appliance to the power supply. Consult a qualified electrician if in any doubt.

► During installation, maintenance and repair work, e.g. if the oven lighting is faulty (see “Problem solving guide”), the oven must be completely disconnected from the household electricity supply. It is only completely isolated from the electricity supply when:

- the circuit breakers have been switched off, or
- the screw-type fuses have been fully unscrewed or
- the power plug (if present) is removed from the outlet. To do this, pull the plug not the cord.

Warnings and safety instructions

- ▶ Multi-socket adapters and extension leads do not guarantee the required safety of the appliance (fire hazard). Do not use these to connect the oven to the domestic power supply.
- ▶ For safety reasons, the oven may only be used when it has been fully installed.
- ▶ Danger of electric shock! Under no circumstances open the outer casing of the appliance.
- ▶ This appliance must not be used in a non-stationary location (e.g. on a ship).
- ▶ Do not repair or replace any part of the appliance unless specifically recommended in the operating instructions. All other servicing should be referred to a qualified technician.
- ▶ Miele can only guarantee the safety of the appliance if genuine Miele spare parts are used. Defective components must only be replaced by genuine Miele spare parts.
- ▶ If the oven is delivered without a power connection cable, or if the power connection cable is damaged, a special cable must be installed by a Miele approved service technician (see “Electrical connection”).
- ▶ The oven requires a sufficient supply of cool air for efficient operation. Make sure that the supply of cool air is not hindered in any way (e.g. by fitting heat insulation strips in the cabinet carcass). Furthermore the required supply of cool air must not be excessively heated by other heat sources (e.g. solid fuel stoves).
- ▶ If the oven is built in behind a furniture front (e.g. a door) do not close the door while the oven is in use. Heat and moisture can build up behind the closed door. This can result in damage to the oven, cabinet carcass and floor. Leave the furniture front/door open until the oven has cooled down completely.

Warnings and safety instructions

Correct use



Danger of burning!

The oven gets hot during operation.

You could burn yourself on the heating elements, oven cavity, food or accessories.





Wear oven gloves when placing food in the oven or removing it and when adjusting oven shelves etc. in a hot oven.

- ▶ **Caution:** Heating elements may be hot even though they are not glowing. Interior surfaces of an oven become hot enough to cause burns. External parts of the oven such as the door glass, vents, and the control panel can become hot. During and after use, do not touch, or let clothing or other flammable materials come into contact with heating elements or interior surfaces of the oven until they have had sufficient time to cool.
- ▶ Do not let food sit in the oven for more than one hour before or after cooking. Doing so can result in food poisoning or sickness.
- ▶ It is important that the heat is allowed to spread evenly throughout the food being cooked and that the temperature is sufficiently high. This can be achieved by stirring and/or turning the food.
- ▶ Use only dry, heat-resistant potholders. Moist or damp potholders used on hot surfaces may result in steam burns. Do not let potholders come in contact with oil or grease. Do not substitute dish towels or other bulky items for potholders. Do not let potholders touch hot heating elements.
- ▶ Loose fitting or hanging garments present a fire hazard. Wear proper apparel while operating the appliance.
- ▶ Canning food or heating it up in closed containers, e.g. tins or sealed jars, results in an increase in pressure which can cause them to explode.
Do not use the oven for canning food or for heating up food in tins.

Warnings and safety instructions

- ▶ Pouring a cold liquid onto a hot surface creates steam which can cause severe scalding. The sudden temperature change can also cause damage to hot enamelled surfaces.
Never pour cold liquids directly onto hot enamelled surfaces.
- ▶ To prevent burns, always place oven racks at their desired height while the oven is cool. If the rack must be moved while the oven is hot, do not let pot holders touch hot heating elements.
- ▶ Open the door carefully to allow hot air or steam to escape before placing or removing food.
- ▶ To prevent burns, allow the heating elements to cool before cleaning by hand.
- ▶ Do not leave the oven door open unnecessarily as someone may trip over it or be injured by it.
- ▶ Oils and fats are a fire hazard if allowed to overheat. Never leave the appliance unattended when cooking with oil or fats.
Never attempt to put out oil or fat fires with water. Switch the oven off and extinguish the flames by leaving the door closed.
- ▶ Never attempt to put out oil or fat fires on the cooktop with water. Switch the cooktop off.
Extinguish the flames on the cooktop carefully with a lid or fire blanket.
- ▶ Never store flammable liquids and materials in, above or under an oven, or near cooking surfaces.
- ▶ To avoid fueling any flames, do not open the oven door if smoke occurs inside the appliance. Interrupt the process by turning the appliance off and disconnecting it from the power. Do not open the door until the smoke has dissipated.
- ▶ Due to the high temperatures radiated, objects left near the oven could catch fire.
Do not use the oven to heat up the room.

Warnings and safety instructions

- ▶ Items left on the cooktop could melt or catch fire from residual heat or if the appliance is turned on by mistake.
Never use the top of a cooker as a place to store items.
- ▶ Broiling food for an excessively long time can cause it to dry out and may result in the food catching fire.
Do not exceed recommended broiling times.
- ▶ Certain foods dry out quickly and may catch fire due to high broiling temperatures.
Never use broiling modes to finish baking par-cooked rolls or bread or to dry flowers or herbs. Use either Convection Bake  or Surround  instead.
- ▶ If using alcohol in your recipes, please be aware that high temperatures can cause the alcohol to evaporate. The vapour can catch fire on hot heating elements.
- ▶ Plastic containers which are not heat-resistant melt and may ignite at high temperatures and can damage the oven.
Use only plastic containers that are suitable for use in an oven.
Follow the manufacturer's instructions.
- ▶ When using residual heat to keep food warm, corrosion from high air humidity and condensation can occur in the oven. This can cause damage to the control panel, countertop and cabinet carcass.
Do not switch the oven off. Instead, select the lowest temperature available for the selected function. The cooling fan will then continue to run automatically.
- ▶ Food which is stored in the oven or left in it to be kept warm can dry out and the moisture released can lead to corrosion damage in the oven.
Always cover food that is left in the oven to keep warm.
- ▶ An accumulation of heat can cause the enamel on the floor of the oven to crack or flake off.
Never line the floor of the oven with aluminium foil or oven liners.
If you wish to place dishes on the floor of the oven during cooking, or place dishes on the floor of the oven to heat it up, you can do so, but only with the Convection Bake  or Eco-Convection  function.

Warnings and safety instructions

- ▶ Do not slide pots or pans over the oven floor. This could scratch and damage the surface.
- ▶ The door can support a maximum load of 15 kg. Do not lean or sit on an open door, or place heavy items on it. Make sure that nothing gets trapped between the door and the oven cavity. This could damage the oven.
- ▶ This oven must only be used for cooking food. Fumes, vapors or heat given off by glues, plastics or flammable liquids and materials could be hazardous. Do not use it as a dryer, kiln, dehumidifier, etc.
- ▶ Do not obstruct the flow of combustion and ventilation air.
- ▶ Do not let metal objects (aluminum foil, pans) come in contact with the heating element.
- ▶ Make certain that the power cords of small appliances do not come in contact with or get caught in the oven door.
- ▶ When baking frozen pizzas or pies, place them on the wire rack lined with parchment paper. Do not use the baking tray or the roasting pan for frozen foods with a large surface area. The tray or pan could become warped and difficult to remove from the oven when hot. Frozen foods like french fries, chicken nuggets, etc. can be baked on the baking tray.

For ovens with a stainless steel front:

- ▶ The coated stainless steel surface can be damaged by adhesives and will lose its protective effect against dirt. Do not adhere sticky notes, transparent tape, masking tape or other adhesives onto the stainless steel surface.
- ▶ The surface is susceptible to scratching. Even magnets can cause scratches.

Warnings and safety instructions

Cleaning and care

- ▶ The steam from a steam cleaning appliance could reach electrical components and cause a short circuit.
Do not use a steam cleaner to clean this appliance.
- ▶ Only clean parts listed in these Operating and Installation Instructions.
- ▶ Scratches on the door glass can cause the glass to break.
Do not use abrasive cleaners, hard sponges, brushes or sharp metal tools to clean the door glass.
- ▶ The side runners can be removed (see “Cleaning and care”).
Make sure that they are reinserted correctly.
- ▶ The catalytic enamelled back panel can be removed for cleaning purposes (see “Cleaning and care”).
Ensure it is correctly fitted after cleaning and never operate the oven without the back panel fitted.

Accessories

- ▶ Miele cookers may only be combined with cooktops specified by Miele as suitable for use with that appliance (see “Electrical connection”).
- ▶ Only use original Miele accessories. Using spare parts or accessories from other manufacturers will invalidate the warranty, and Miele cannot accept liability.
- ▶ The Miele oven dishes HUB 5000-M/HUB 5001-M/HUB 5000-XL/HUB 5001-XL (if available) must not be inserted on shelf level 1. This will damage the floor of the oven. The lack of clearance will create an accumulation of heat which can cause the enamel to crack or flake off. Do not place the Miele oven dishes on the upper support of shelf level 1 as they will not be secured by the non-tip safety notches.
As a general rule, use shelf level 2.

SAVE THESE INSTRUCTIONS AND REVIEW THEM PERIODICALLY

Disposal of the packaging material

The cardboard box and packaging materials protect the appliance during shipping. They have been designed to be biodegradable and recyclable.

Recycling the packaging reduces the use of raw materials in the manufacturing process and also the amount of waste.

Disposal of your old appliance

Electronic and electrical appliances contain many valuable materials. They also contain certain materials, compounds and components which were essential for the proper functioning and safe use of the equipment. These could be hazardous to your health and to the environment if disposed of with general waste or if handled incorrectly. Therefore, please do not dispose of your old appliance with general waste.



Consult with local authorities, dealers or Miele in order to dispose of and recycle electrical and electronic appliances. Miele assumes no responsibility for deleting any personal data left on the appliance being disposed. Please ensure that your old appliance is kept away from children until removal. Observe safety requirements for appliances that may tip over or pose an entrapment hazard.

Guide to the cooker

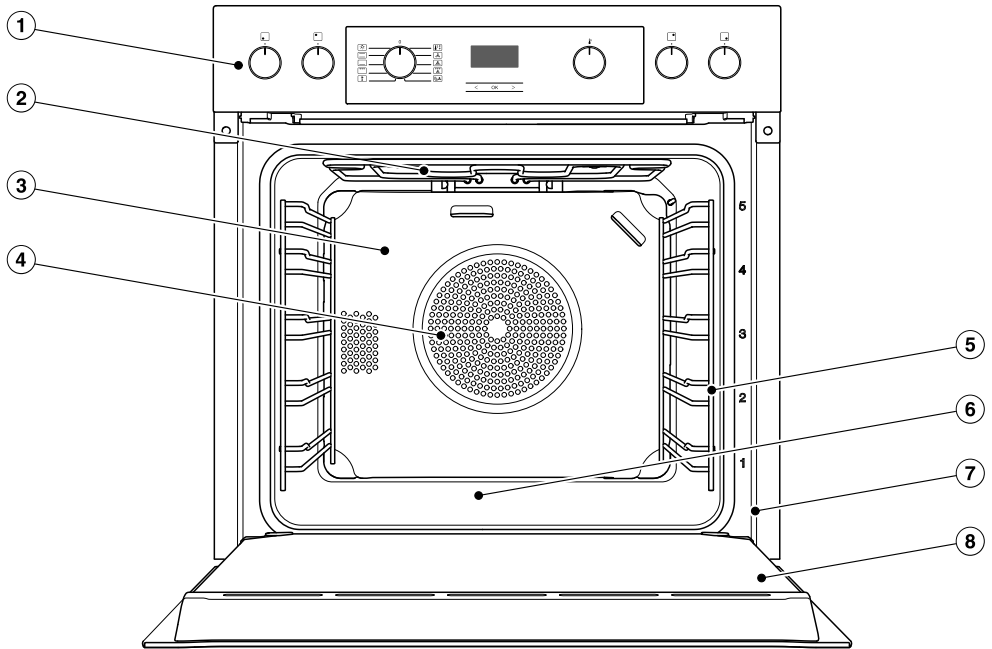

- ① Oven controls, cooking zone controls
- ② Browning/broiling element
- ③ Catalytic enamelled back panel
- ④ Air inlet for the fan with ring heating element behind it
- ⑤ Side runners with 5 shelf levels
- ⑥ Oven floor with bottom heat element underneath it
- ⑦ Front frame with data plate
- ⑧ Door

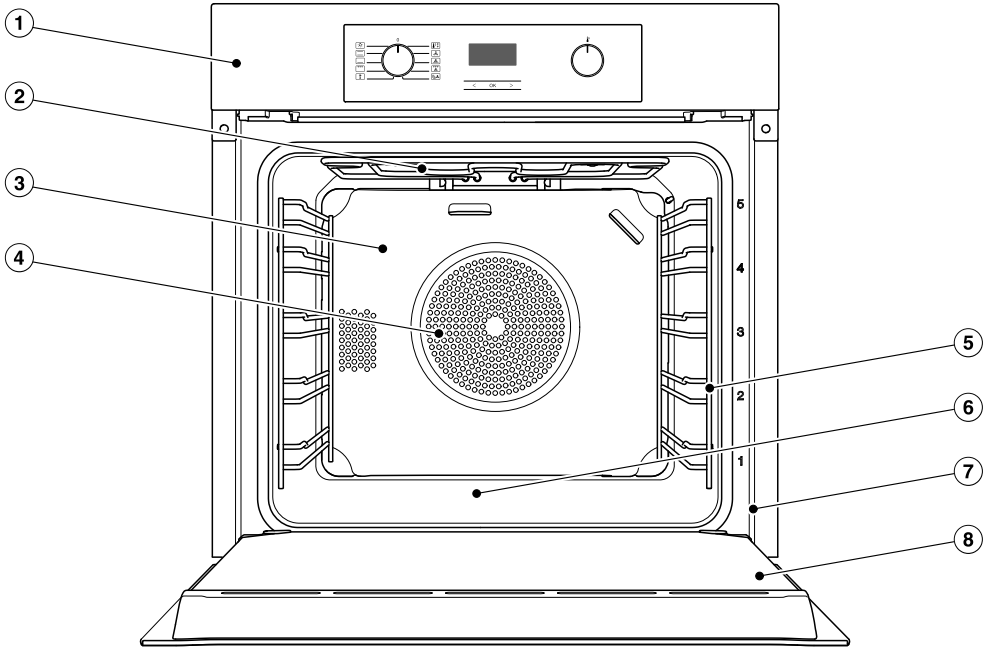

- ① Oven controls
- ② Browning/broiling element
- ③ Catalytic enamelled back panel
- ④ Air inlet for the fan with ring heating element behind it
- ⑤ Side runners with 5 shelf levels
- ⑥ Oven floor with bottom heat element underneath it
- ⑦ Front frame with data plate
- ⑧ Door

Oven controls

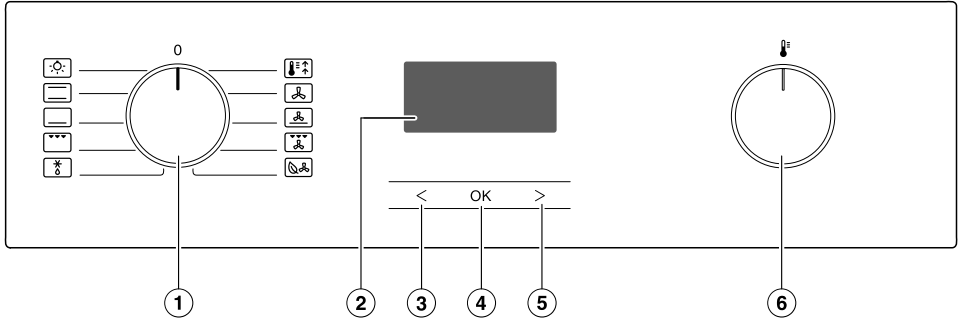

- ① Function selector
For selecting oven functions
- ② Clock/timer
For displaying the time of day and settings
- ③ < button
For modifying times and settings
- ④ OK button
For selecting functions and confirming settings
- ⑤ > button
For modifying times and settings
- ⑥ Temperature selector
For setting the temperature

Function selector

The function selector is used to select oven functions and to turn on the oven lighting independently.

It can be turned clockwise or counter-clockwise.

When the function selector is in the **0** position, it can be retracted by pushing it in.

Operating modes

-  *Lighting*
-  *Surround*
-  *Bake*
-  *Maxi Broil*
-  *Defrost*
-  *Booster*
-  *Convection Bake*
-  *Intensive*
-  *Convection Broil*
-  *Eco-Convection*

Temperature selector

Use the temperature selector to select the temperature for the cooking processes.

It can be turned clockwise and anti-clockwise. It can be retracted in any position by pushing it in.

Clock/timer

The clock/timer is operated via the **display** and the **<**, **OK** and **>****sensor controls**.

Display

The display shows the time of day or your settings.

It goes slightly darker if settings are not being entered.

Please refer to “Clock/timer” for more information.

Sensor controls

The sensor controls respond to the touch of a fingertip. Every touch on the sensors is confirmed by an audible tone.

The tone can be switched off by changing setting *P 4* to status *5 /* (see “Clock/timer – Changing settings”).

Features

Model designation

A list of the ovens described in these operating instructions can be found on the back page.

HxxxxE/ Cooker = Oven +
Hxxxxl integrated cooktop
 controls

HxxxxB Oven

The descriptions of the oven functions apply to cookers and ovens. However, both types of appliance are generally referred to as “oven” throughout.

Data plate

The data plate located on the front frame of the oven is visible when the door is open.

The model number, serial number and the connection data (voltage/frequency/maximum rated load) of the oven are printed on the data plate.

Please have this information to hand, should you need to contact Miele regarding any questions or problems.

Items supplied

The appliance is supplied with:

- The operating and installation instructions for using the oven functions
- Screws for fixing the oven to the cabinet carcass
- Various accessories

With all cookers, an additional operating and installation instruction booklet is supplied for the cooktop.

Standard and optional accessories

Features will vary depending on model.

Side runners, universal tray and wire rack are supplied as standard with the oven.

Depending on the model, your oven may also come supplied with some of the accessories listed here.

All accessories and cleaning and care products in these instructions are designed to be used with Miele ovens.

They can be ordered from the Miele.ca website or Miele.

When ordering, please have ready the model number of your oven and of the desired accessories.

Side runners

Side runners for accessories are fitted on either side of the oven cavity for shelf levels ⁵₁.

The numbers for the shelf levels are marked on the front frame.

Each level consists of two rails, one above the other.

Accessories (e.g. the rack) can be used on any level. They are pushed into the oven between the two rails.

The side runners can be removed (see “Cleaning and care”).

Baking tray, universal tray and rack with non-tip safety notches

Baking tray HBB 71:

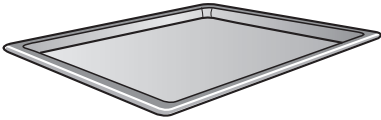

Universal tray HUBB 71:

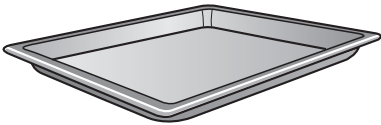

Rack HBBR 71:

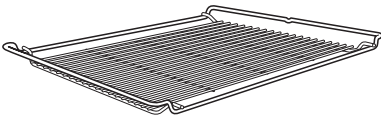

These accessories are inserted into the oven between the two rails of a side runner.

Always position the rack with the loading surface in the lower position.

These accessories have non-tip safety notches fitted in the middle of their short sides. The non-tip safety notches prevent the trays from being pulled out completely when you only wish to pull them out partially.



If you are using the universal tray with the rack on top, insert the tray between the rails of the side runners and the rack will automatically slide in above them.

The enamel parts have been treated with the PerfectClean finish.

FlexiClip runners HFC 70-C

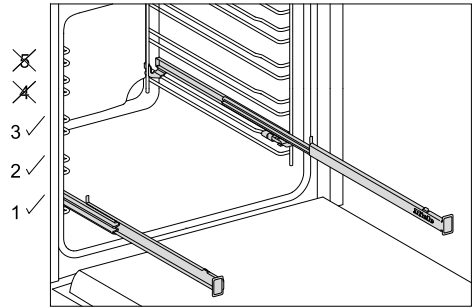

FlexiClip runners can only be fitted on levels 1, 2 and 3.

The FlexiClip runners can be drawn right out of the oven to give a good overview of cooking in progress.

Push the FlexiClip runners right into the oven cavity before placing accessories on them.

Features

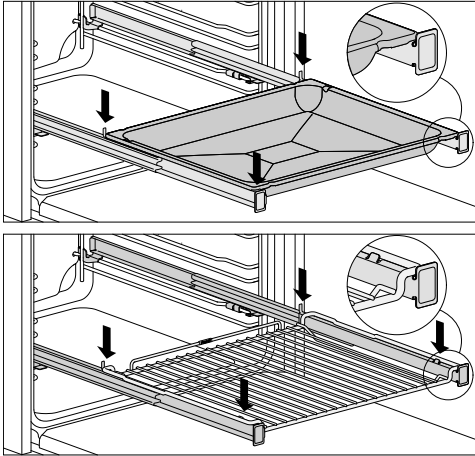

To prevent the risk of accessories sliding off the runners:

- Make sure that they are sitting securely on their runners in between the stoppers at either end of each runner.
- Always place the rack with the loading surface in the lower position on the FlexiClip runners.

The FlexiClip runners can support a maximum load of 15 kg.

Because the FlexiClip runners sit on the top rail of the side runners, the gap between the level the FlexiClip runners are on and the one above is smaller than if, for instance, racks were fitted on each level. Cooking results will be affected if the gap is too small.

If you need to use more than one baking tray, universal tray or rack at a time:

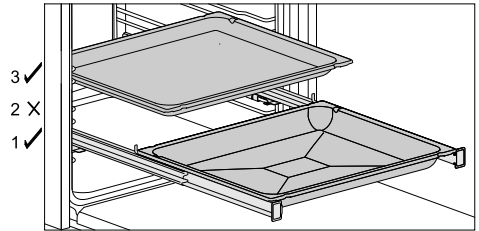

- Place one baking tray, universal tray or rack on the FlexiClip runners.
- Leave at least one shelf level free between it and any baking tray, universal tray or rack above it.

If you are using the universal tray with a rack on top of it:

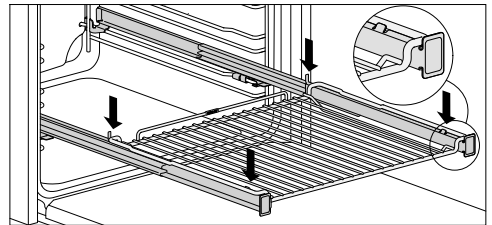

- Place the universal tray together with the rack on the FlexiClip runners. The rack will automatically slide between the rails of the shelf level above the FlexiClip runners.
- Leave at least one shelf level free between it and any baking tray, universal tray or rack above it.

Fitting the FlexiClip runners

⚠ Danger of burning!
Make sure the oven heating elements are switched off. The oven must be cool.

Preferably fit the FlexiClip runners onto level 1. You can then use them for food which should be cooked on level 2.

One level of the side runners consists of two rails. The FlexiClip runners are fitted on the upper rail of the two rails that make up a shelf level.

The FlexiClip runner with the Miele logo is fitted on the right.

When fitting the FlexiClip runners, **do not** extend them. If the FlexiClip runners are difficult to pull out after fitting, you may need to pull firmly on them once to release them.

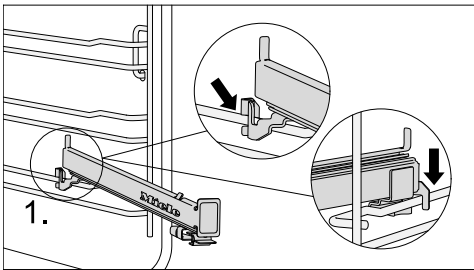

- Hook the FlexiClip runner onto the front of the top rail of a side runner (1.).

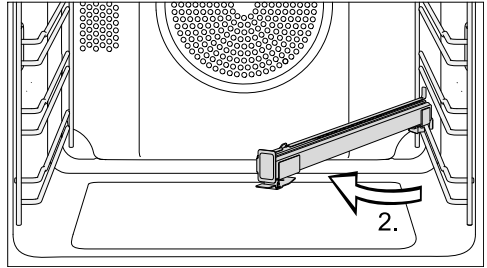

- Then swivel it in towards the middle of the oven cavity (2.).

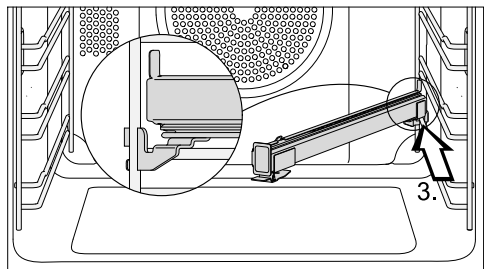

- Slide the FlexiClip runner at an angle along the top rail as far as it will go (3.).

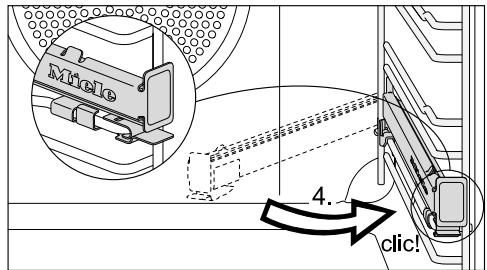

- Then swivel it back to the side of the oven cavity and secure it to the top rail with an audible click (4.).

Features

Removing the FlexiClip runners

- Push the FlexiClip runner in all the way.

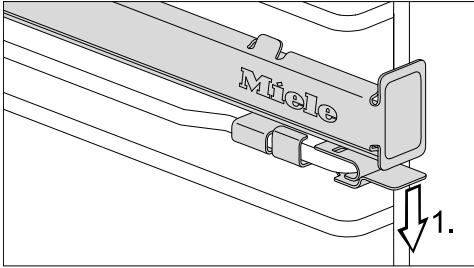

- Push down on the tab at the front of the FlexiClip runner (1.).

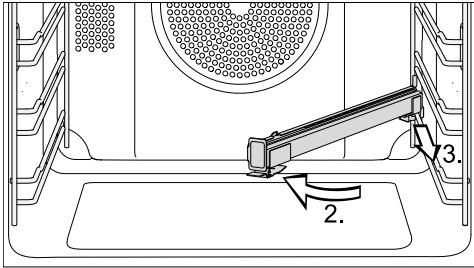

- Swivel the FlexiClip runner towards the middle of the oven cavity (2.), then pull it forwards along the top rail (3.).
- Lift the FlexiClip runner off the rail and take it out of the oven.

Round baking tray HBF 27-1



The round baking tray is suitable for cooking pizzas, flat cakes made with yeast or whisked mixtures, sweet and savoury tarts, baked desserts, flat bread, and can also be used for frozen cakes and pizzas.

The enamelled surface has been treated with PerfectClean.

Perforated Gourmet baking tray HBBL 71

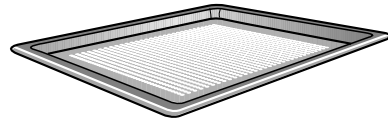

The perforated Gourmet baking tray has been specially developed for the preparation of baked goods made from fresh yeast and quark doughs.

The tiny perforations assist in browning the underside of baked goods.

The tray can also be used for dehydrating or drying food.

The enamelled surface has been treated with PerfectClean.

The **round perforated baking tray HBFP 27-1** can be used for the same things.

Baking stone HBS 70



The baking stone is ideal for items which need a well baked base such as pizza, quiche, bread, bread rolls and savoury snacks.

The baking stone is made from heat-retaining fireclay and is glazed. Place it directly on the rack.

A paddle made of untreated wood is supplied with the baking stone for placing food on it and taking it off.

Anti-splash insert HGBB 71

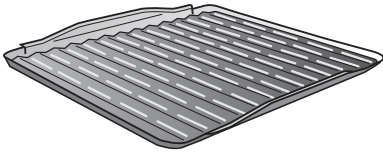

The anti-splash insert fits in the universal tray.

When broiling or roasting, it collects the meat juices and stops them burning so they can be used to make gravy and sauces.

The enamelled surface has been treated with PerfectClean.

HUB Gourmet oven dishes HBD oven dish lids

Unlike other oven dishes, the Miele Gourmet oven dishes can be placed in the oven directly on the side runners. They have non-tip safety notches like the rack to prevent them from being pulled out too far.

They have a non-stick coating.

Gourmet oven dishes are available in different depths. The width and height are the same in each case.

Lids are also available. These are ordered separately. Please quote the model number when ordering.

Depth: 22 cm

HUB 5000-M
HUB 5001-M *

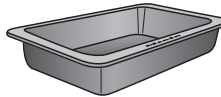

HBD 60-22

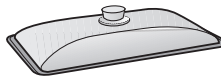

Depth: 35 cm

HUB 5001-XL *

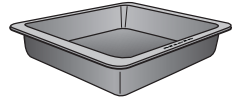

HBD 60-35

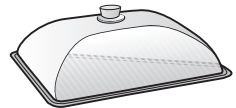

* suitable for use on induction cooktops

Features

Catalytic enamelled accessories

- Side walls
These are installed behind the side runners and protect the interior walls against soiling.
- Back panel
This should be replaced if the catalytic enamel has become ineffective due to incorrect use or very heavy soiling.

When ordering, please quote the model number of your oven.

Handle HEG

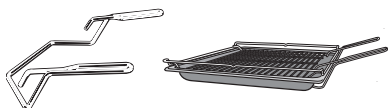

The handle makes it easier to take the universal tray, baking tray and rack out of the oven.

Miele all-purpose microfibre cloth

Light soiling and fingerprints can be easily removed with the microfibre cloth.

Miele oven cleaner

Miele oven cleaner is suitable for removing stubborn soiling. It is not necessary to preheat the oven before use.

Oven safety features

Oven system lock

The system lock prevents the oven from being used unintentionally (see “Clock/timer – Changing settings – P 3”).

When the system lock is activated,  appears on the display.

Cooling fan

A cooling fan will come on automatically when a cooking program is started. The cooling fan mixes hot air from the oven cavity with cool room air before venting it out into the kitchen through vents located between the appliance door and the control panel.

The cooling fan will continue to run for a while after the oven has been switched off to prevent any humidity building up in the oven, on the control panel or in the cabinet carcass.

The cooling fan will switch itself off automatically after a certain period of time.

Vented oven door

The oven door is made of glass panes that have a heat-reflective coating on part of their surface.

When the oven is operating, air is passed through the door to keep the outer pane cool.

The door can be removed and disassembled for cleaning purposes (see “Cleaning and care”).

PerfectClean treated surfaces

PerfectClean surfaces have very good non-stick properties and are exceptionally easy to clean.

Food and soiling from baking and roasting can be easily removed from these surfaces.

Food can be sliced or cut up on PerfectClean surfaces.

However, do not use ceramic knives as these will scratch the PerfectClean surface.

Surfaces treated with PerfectClean enamel can be cleaned as you would clean glass.

Read the instructions in “Cleaning and care” so that the benefits of the non-stick properties and exceptionally easy cleaning are retained.

The following have all been treated with PerfectClean:

- Oven cavity
- Universal tray
- Baking tray
- Anti-splash insert
- Perforated Gourmet baking tray
- Round baking tray
- Round perforated baking tray

Catalytic enamelled surfaces

The back panel is coated with catalytic enamel. Soiling from oil and fat is burnt off this type of surface when very high temperatures are used in the oven.

See “Cleaning and care”.





Cooktop controls

(features will vary depending on model)

HxxxxE/HxxxxI cookers also have cooking zone controls for operating the cooking zones on the linked cooktop.

All the cooking zone controls are retractable when they are at the  position. The range of settings is printed on the control.

Cooking zone controls:

Symbol	Cooking zone
	Front left
	Rear left
	Rear right
	Front right

The cooktop can still be operated when the system lock for the oven is switched on .

Please read the separate operating and installation instructions provided with your cooktop. It contains additional information on how to install and use your cooktop.

Initial commissioning

Before using for the first time

 The oven must not be operated until it has been correctly installed in the cabinet carcass.

- Press and release the function and temperature selectors if they are retracted.

The time of day can only be changed when the function selector is at **0**.

- Set the time of day.

Setting the time of day for the first time

The time of day is shown in 24 hour clock format.



After connecting the oven to the electricity supply, *12:00* will flash on the display.

The time of day is set in segments: first the hours, then the minutes.

- Confirm with *OK*.

12:00 will light up and  will flash.

- While the  symbol is flashing, confirm with *OK*.

The hours will flash.

- Use *<* or *>* to set the hours.
- Confirm with *OK*.

The hours are saved and the minutes will flash.

- Use *<* or *>* to set the minutes.
- Confirm with *OK*.

The time of day is now saved.

The time of day can be displayed in 12 hour format by setting *P 2* in the settings menu to status *12* (see “Clock/timer – Changing settings”).

Heating up the oven for the first time

When the oven is heated up for the first time it may give off a slight smell. This can be eliminated by heating the empty oven for at least an hour.

It is important to ensure that the kitchen is well ventilated during this operation. Prevent the odour from escaping into other rooms.

- Remove any protective wrapping and stickers from the oven and accessories.
- Take all accessories out of the oven and clean them (see “Cleaning and care”).
- Before heating the oven up, wipe the interior with a damp cloth to remove any dust or bits of packaging that may have accumulated in the oven cavity during storage and unpacking.
- Select Convection Bake .

The recommended temperature of 325 °F/160 °C will appear highlighted. The oven heating, lighting and cooling fan will switch on.

- Set the maximum temperature (475 °F/250 °C).
- Heat the empty oven for at least an hour.
- After the heating up process has finished, turn the function selector to **0**.











 Danger of burning! Allow the oven to cool before cleaning.

- Clean the oven cavity with warm water and liquid dish soap, applied with a clean sponge cloth or a clean, damp microfibre cloth.
- Dry all surfaces with a soft cloth.



Leave the oven door open until the oven cavity is completely dry.

Overview of functions

The oven has a wide range of functions for preparing a variety of foods. Due to country-specific preferences for preparation of food, default temperatures and temperature ranges in °F and °C do not correspond. The temperature values have been defined as given in the chart.

Function	Description
Surround 	For baking and roasting traditional recipes, cooking soufflés and cooking at low temperatures. If using an older recipe or cookbook, set the oven temperature 20 °F/10 °C lower than that recommended. This won't change cooking times.
Bake 	Use this function towards the end of cooking to brown the base of a cake, quiche or pizza.
Broil 	For broiling thin cuts (e.g. steaks) and for browning baked dishes.
Defrost 	For the gentle defrosting of frozen food.
Booster 	For rapid preheating of the oven cavity. Once the desired temperature has been reached the oven mode must be selected.
Convection Bake 	For baking and roasting. You can cook on several shelf levels at the same time. Because the fan distributes the heat to food straight away, it allows you to use a lower temperature than you would with Surround  .
Intensive 	For baking cakes with moist toppings. Intensive mode is not suitable for baking thin items or for roasting as the juices will become too dark.
Convection Broil 	For broiling thicker items (e.g. chicken). Because the fan distributes the heat to food straight away, it allows you to use a lower temperature than you would with Broil  .
Eco-Convection 	Suitable for small amounts, e.g. frozen pizzas, bake-off rolls, biscuits and for meat dishes and roasts. You can save up to 30 % energy compared to cooking with a standard oven function as long as the door is kept shut during cooking. The oven lighting does not switch on in this function.

Cooking

- Remove all accessories from the oven that are not required for a cooking process.
- Preheat the oven only if instructed to do so in the recipe or the cooking chart.
- Try not to open the door during cooking processes.
- In general, if a range of temperatures is given in a recipe or chart, it is best to select the lower temperature and to check the food after the shortest duration.
- Use dark, matt bakeware and cooking containers made of non-reflective materials (enamelled steel, heat-resistant glass, coated aluminium). Shiny materials such as stainless steel or aluminium reflect the heat and therefore can give a more uneven result. Do not cover the oven floor or the rack with heat-reflecting aluminium foil.
- Monitor cooking durations to avoid wasting energy when cooking.
- Wherever possible set the cooking duration, or use a roast probe.
- Convection Bake  can be used for cooking many types of food. Because the fan distributes the heat to food straight away, it allows you to use a lower temperature than you would with Surround . It also enables you to cook on several shelf levels at the same time.
- Eco-Convection  is an innovative function that makes optimum use of residual heat. You can save up to

30 % energy compared to cooking with a standard oven function as long as the door is kept shut during cooking.

- Convection Broil  can be used for a wide variety of food. With Convection Broil you can use lower temperatures than with other broil functions which use the maximum temperature setting.
- Whenever possible you should cook several dishes at the same time. Place them next to each other in the oven or on different shelf levels.
- Dishes which you are unable to cook at the same time should, if possible, be cooked one after the other in order to make use of existing heat in the oven.

Residual heat utilization

- The temperature in cooking programs using temperatures above 285 °F/140 °C which take longer than 30 minutes to cook can be turned down to the lowest possible temperature about 5 minutes before the end of cooking. The residual heat in the oven is sufficient for cooking the food. Do not switch the oven off (see “Warning and safety instructions”).
- If you wish to clean catalytic enamelled parts of the oven, it is best to do so immediately after a cooking program. The residual heat in the oven will help reduce the amount of energy required.

Using the oven

Simple operation

- Place the food in the oven.
- Select the required oven function with the function selector.

The recommended temperature appears.

The oven lighting, heating and the cooling fan will switch on.

- Use the temperature selector to set the temperature if necessary.

After cooking:

- Turn the function selector to **0**.
- Take the food out of the oven.

Cooling fan

The cooling fan will continue to run for a while after the oven has been switched off to prevent any humidity building up in the oven, on the control panel or in the cabinet carcass.

The cooling fan will switch itself off automatically after a certain period of time.

Preheating the oven

It is only necessary to preheat the oven in a few instances.

Most dishes can be placed in a cold oven. They will then make use of the heat produced during the heating-up phase.

The oven should be preheated in the following instances:

Convection Bake

- dark bread doughs
- beef sirloin joints and fillet

Surround

- cakes or biscuits with a short baking time (up to 30 minutes)
- delicate mixtures (e.g. sponges)
- dark bread doughs
- beef sirloin joints and fillet

Booster

With Booster  the heating-up phase can be shortened.

Do not use Booster  to preheat the oven when baking pizzas or delicate mixtures (e.g. sponges, biscuits).

They will brown too quickly on top.

- Select Booster .
- Select a temperature.
- When the required temperature is reached, set the oven function you require for continued cooking.
- Place the food in the oven.

Clock/timer

The clock/timer offers the following functions:

- Time of day display
- Minute minder
- Switching cooking processes on and off automatically
- Altering settings *P*

The clock/timer is operated via the **display** and the **sensor controls** <, *OK* and >.

The functions available are indicated by symbols.

Display

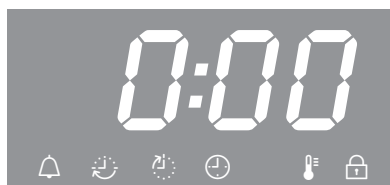

Symbols on the display

Depending on the position of the function selector \odot and/or whether a sensor has been pressed, the following symbols appear:

Symbol/function		\odot
	Minute minder	Any
	Cooking duration	Function
	End of cooking duration	
	Temperature	
	Time of day	0
<i>P</i>	Setting	
5	Setting status	
	System lock	

You can only set or change a function if the function selector is in the correct position.

Buttons

Button	Use
<	<ul style="list-style-type: none"> - Highlight functions - Reduce duration - Access settings <i>P</i> - Change the status 5 of a setting <i>P</i>
>	<ul style="list-style-type: none"> - Highlight functions - Increase duration - Change the status 5 of a setting <i>P</i>
<i>OK</i>	<ul style="list-style-type: none"> - Access functions - Save set durations and changed settings - Access set durations

Set minutes or seconds with < or > in increments of 1.

If you hold the button down the display will count faster.

Setting the time

Times are set in segments:

- for the time of day and cooking durations, first the hours, then the minutes,
- for a minute minder duration, first the minutes, then the seconds.

■ Confirm with *OK*.

The respective functions appear depending on the position of the function selector (⏰, ⌚, ⌚ or ⌚).

■ Highlight the function you want using < or >.

The appropriate symbol will flash for approx. 15 seconds.

■ While the symbol is flashing, confirm with *OK*.

The function is accessed and the left-hand numeric block will flash.

You can only set the time while the numeric block is flashing. If the time has elapsed and the numeric block is no longer flashing, you have to access the function again.

■ Use < or > to set the time you want.

■ Confirm with *OK*.

The right-hand numeric block will flash.

■ Use < or > to set the time you want.

■ Confirm with *OK*.

The time has now been saved.

Time display

The symbols ⏰ and ⌚ or ⌚ will show if you have set times.

If you are using the minute minder ⏰, cooking duration ⌚ and end of cooking duration ⌚ functions at the same time, the last time that you set will be shown.

If you have set a cooking duration, the time of day will not be displayed.

At the end of the duration

When a duration has elapsed, the appropriate symbol will flash and a buzzer will sound if the buzzer is switched on (see “Clock/timer – Changing settings”).

■ Confirm with *OK*.

The buzzer will stop and the symbols in the display will go out.

Clock/timer

Using the minute minder

The minute minder can be used to time other activities in the kitchen, e.g. boiling eggs.

The minute minder can also be used at the same time as a cooking program for which the start and finish times have been set (e.g. as a reminder to stir a dish or add seasoning, etc.).

A maximum minute minder time of 99 minutes and 59 seconds can be set.

Setting the minute minder

Example: You want to boil some eggs and set a minute minder duration of 6 minutes and 20 seconds.



- Press < continuously until  flashes.
- Confirm with OK.



00:00 will appear and the minutes will start to flash.

If you press < once, two dashes will appear and then when you press again the maximum possible minutes will appear in the minute numeric block 99.



- Use < or > to set the minutes.
- Confirm with OK.

The minutes are saved and the seconds will flash.



- Use < or > to set the seconds.
- Confirm with OK.



The minute minder duration is now saved and will count down in seconds.

The  symbol indicates the minute minder duration.

At the end of the minute minder duration:

- 🔔 flashes.
- The display will show the time counting upwards.
- For approx. 7 minutes, a buzzer will sound if switched on (see “Clock/timer – Changing settings”).

- Confirm with *OK*.

The buzzer will stop and the symbols in the display will go out.

If no cooking durations have been set, the time of day appears in the display.

Changing the minute minder duration

- Press < continuously until 🔔 flashes.

The minute minder duration selected will appear.

- Confirm with *OK*.

The minutes will flash.

- Use < or > to set the minutes.

- Confirm with *OK*.

The seconds will flash.

- Use < or > to set the seconds.

- Confirm with *OK*.

The changed minute minder duration is now saved and will count down in seconds.

Deleting the minute minder duration

- Press < continuously until 🔔 flashes.
- Confirm with *OK*.

The minutes will flash.

- Reduce the minutes down to 00 using < or increase them up to 99 using >.

The next time the button is pressed two dashes will appear in place of the minutes:



- Confirm with *OK*.

Four dashes appear:





- Confirm with *OK*.

The minute minder duration is now cancelled.

If no cooking durations have been set, the time of day appears in the display.

Clock/timer

Switching cooking programs on and off automatically

Cooking programs except Broil  and Convection Broil  can be switched on or off automatically.

To do this, set a duration or a duration and finish time after selecting an oven function and a temperature.

The maximum duration which can be set for a cooking program is 11 hours and 59 minutes.

We recommend switching on and off automatically when roasting. If used for baking, do not delay the start for too long. Cake mixture or dough will dry out, and the raising agents will lose their effectiveness.

Setting the cooking duration

Example: a cake needs to bake for 1 hour and 5 minutes.

- Place the food in the oven.
- Select the required oven function and the temperature.

The oven heating, lighting and cooling fan will switch on.

- Press > continuously until  flashes.

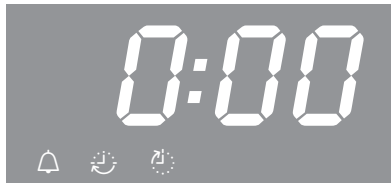

0:00 will appear.

- Confirm with OK.

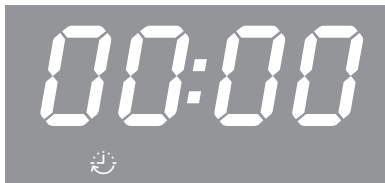

00:00 will appear and the hours will flash.

If you press < once, two dashes will appear and then when you press again the maximum possible hours will appear in the hour numeric block #.

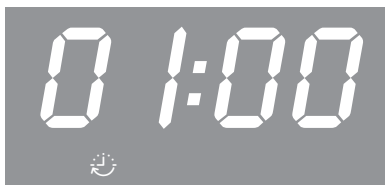

- Use < or > to set the hours.
- Confirm with OK.

The hours are saved and the minutes will flash.

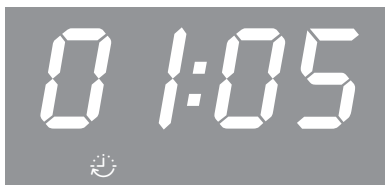

- Use < or > to set the minutes.
- Confirm with OK.



The cooking duration is now saved and will count down in minutes until the last minute, which will count down in seconds.

The  symbol indicates the cooking duration.

At the end of the cooking duration:

- 0:00 will appear.
-  flashes.
- The oven heating will switch off automatically.
- The cooling fan continues to run.
- For approx. 7 minutes, a buzzer will sound if switched on (see “Clock/timer – Changing settings”).
- Confirm with **OK**.
- The buzzer will stop and the symbols in the display will go out.
- The time of day appears.
- The oven heating will then switch on again.
- Turn the function selector to **0**.
- Take the food out of the oven.

Setting a cooking duration and end of cooking duration

To switch a cooking process on and off automatically you can set a cooking duration and an end of cooking duration.

Example: the current time of day is 11:15; a roast with a cooking duration of 90 minutes needs to be ready at 13:30.

- Place the food in the oven.
- Select the required oven function and the temperature.

The oven heating, lighting and cooling fan will switch on.

First set the cooking duration:

- Press **>** continuously until  flashes.
- Confirm with **OK**.

00:00 will appear and the hours will flash.

- Use **<** or **>** to set the hours.
- Confirm with **OK**.

The hours are saved and the minutes will flash.

- Use **<** or **>** to set the minutes.
- Confirm with **OK**.

The cooking duration is now saved.

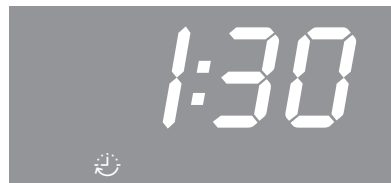

The  symbol indicates the cooking duration.

Clock/timer

Then set the end of cooking duration:

- Press > continuously until  flashes.

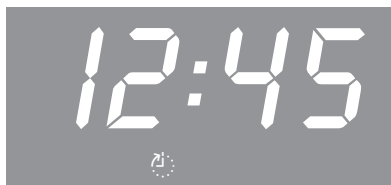

12:45 (= current time of day + cooking duration = 11:15 + 1:30) appears in the display.

- Confirm with OK.

The hours will flash.



- Use < or > to set the hours.
- Confirm with OK.

The hours are saved and the minutes will flash.



- Use < or > to set the minutes.
- Confirm with OK.

The end of cooking duration  is now saved.

The oven heating, lighting and cooling fan will switch off.

The selected end of cooking duration will then appear in the display.

As soon as the start time (13:30 - 1:30 = 12:00) has been reached, the oven heating, lighting and cooling fan will switch on.

The cooking duration set  appears and will count down in minutes until the last minute, which will count down in seconds.

Changing the cooking duration

- Press > continuously until  flashes.

The time remaining will appear in the display.

- Confirm with OK.

The hours will flash.

- Use < or > to set the hours.
- Confirm with OK.

The minutes will flash.

- Use < or > to set the minutes.
- Confirm with OK.

The changed cooking duration is now saved.

Deleting a cooking duration

- Press < or > continuously until  flashes.

- Confirm with OK.

The hours will flash.

- Press < or > continuously until two dashes appear:

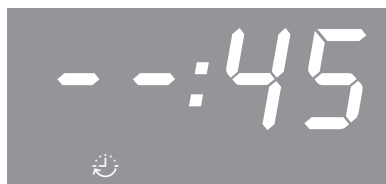

- Confirm with OK.

Four dashes appear:

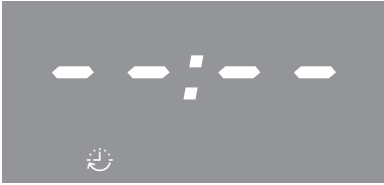

- Confirm with *OK*.

The cooking duration and any end of cooking duration set will be deleted.

The time of day appears when no minute minder duration is set.

The oven heating, lighting and cooling fan will switch on.

If you want to end the cooking process:

- Turn the function selector to **0**.
- Take the food out of the oven.

Deleting the end of cooking duration

- Press < or > continuously until  flashes.
- Confirm with *OK*.

The hours will flash.

- Press < or > continuously until two dashes appear.
- Confirm with *OK*.

Four dashes appear.

- Confirm with *OK*.

The  symbol appears and the cooking duration set will count down in minutes until the last minute, which will count down in seconds.

If you want to end the cooking process:

- Turn the function selector to **0**.

- Take the food out of the oven.

If the function selector is turned to the **0** position, the settings for cooking duration and end of cooking duration will be deleted.

Changing the time of day

The time of day can only be changed when the function selector is at **0**.

- Turn the function selector to **0**.
- Press > continuously until  flashes.
- Confirm with *OK*.

The hours will flash.

- Use < or > to set the hours.
- Confirm with *OK*.

The hours are saved and the minutes will flash.

- Use < or > to set the minutes.
- Confirm with *OK*.

The time of day is now saved.

The time of day must be reset following an interruption to the power supply.

Clock/timer

Changing settings

Default settings are set in the oven controls at the factory (see “Settings overview”).

You change a setting *P* by changing its status *S*.

- Turn the function selector to **0**.
- Press < continuously until *P* / flashes:



- If you want to change another setting, press < or > continuously until the relevant digit appears.
- Confirm with **OK**.



The setting is selected and the current status *S* appears, e.g. *0*.

To change the status:

- Press < or > continuously until the status you want is shown.
- Confirm with **OK**.

The selected status is now saved and the setting *P* appears again.

To change further settings, proceed in the same way.

If you do not want to change further settings:

- Wait approx. 15 seconds until the time of day appears.

The settings are retained in the event of an interruption to the power supply.

Settings overview



Setting	Status
<i>P 1</i> Buzzer volume	<p>5 0 The buzzer is switched off.</p> <p>5 1 to 5 30* The buzzer is switched on. You can adjust the volume. When you select a status, you will hear the corresponding buzzer.</p>
<i>P 2</i> Time of day format	<p>24* The time of day is shown in a 24-hour format.</p> <p>12 The time of day is shown in the 12-hour format. If you change the clock after 1:00 pm from a 12-hour clock to a 24-hour clock you will need to update the hour accordingly.</p>
<i>P 3</i> Oven system lock	<p>5 0* The system lock is switched off.</p> <p>5 1 The system lock is switched on and  appears on the display. The system lock prevents the oven from being used unintentionally. The system lock remains active even after a power failure.</p>
<i>P 4</i> Keypad tone	<p>5 0 The keypad tone is switched off.</p> <p>5 1* The keypad tone is switched on.</p>
<i>P 5</i> Temperature display	<p>°C* The temperature is displayed in degrees Celsius.</p> <p>°F The temperature is displayed in degrees Fahrenheit.</p>

* Default setting

Baking



Handling food carefully will help protect your health.
Cakes, pizzas and french fries should be cooked until golden, not dark brown.

Operating modes

Depending on how the food is prepared, you can use Convection Bake , Intensive  or Surround .

Bakeware

The bakeware used depends on the oven function and how the food is prepared.

- Convection Bake , Intensive : baking tray, universal tray, any heat-resistant baking dishes.
- Surround : Dark bakeware with a matt finish. Avoid using bright, shiny metal tins as they give an uneven and poor browning result and in some cases cakes might not cook properly.
- Always place bakeware on the rack. Position rectangular tins with the longer side across the width of the rack for optimum heat distribution and even baking results.
- Bake cakes with fruit toppings or deep cakes on the universal tray.

Baking paper, greasing the tin

Miele accessories, e.g. the universal tray, are treated with PerfectClean enamel (see “Features”).

Surfaces treated with PerfectClean enamel generally do not need to be greased or covered with baking paper.

Baking paper is only necessary when baking:

- anything prepared using a lye containing sodium hydroxide (e.g. pretzels, bread sticks), because the lye can damage the PerfectClean surface.
- meringues or sponges with a high egg white content
These are more likely to stick.
- frozen food cooked on the wire oven rack.

Notes on using the baking charts

In the charts the data for the recommended function is printed in bold.

Unless otherwise stated, the durations given are for an oven which has not been preheated. With a preheated oven, shorten times by around 10 minutes.

Temperature

As a general rule, select the lower temperature given in the chart.

Choosing a baking temperature higher than those recommended may reduce the cooking time, but will lead to uneven browning, and unsatisfactory cooking results.

Baking duration

As a general rule, check the food after the shortest duration. Stick a skewer into the food. If it comes out clean without any batter/dough on it, the food is done.

Shelf level

The shelf level on which you place your food depends on the function selected and the number of trays.

- **Convection Bake**

- 1 tray: shelf level 2
- 2 trays: shelf levels 1+3/2+4
- 3 trays: shelf levels 1+3+5

If you are using the universal tray and baking trays on a number of levels at the same time, place the universal tray underneath the baking trays.

For moist biscuits and cakes, bake on a maximum of two shelf levels at once.

- **Intensive**

- 1 tray: shelf level 1 or 2

















- **Surround**

- 1 tray: shelf level 1 or 2



Baking

Baking charts

Creamed mixture

















Cakes/ biscuits		 [°F/°C]	 ⁵ ₁	 [min]
Muffins (1 tray)		275-300/140-150	2²⁾	30-40
		300-325/150-160	2 ²⁾	30-40
Muffins (2 trays)		275-300/140-150	2+4²⁾	35-45³⁾
Small cakes (1 tray)		300/150	2	25-40
		325/160¹⁾	3	20-30
Small cakes (2 trays)		300/150¹⁾	2+4	20-30
Small cakes/biscuits (1 tray)		275-300/140-150	2²⁾	25-35
		300-325/150-160 ¹⁾	3 ²⁾	15-25
Small cakes/biscuits (2 trays)		275-300/140-150	2+4²⁾	25-35³⁾
Sponge cake		300-325/150-160	2 ²⁾	60-70
		300-325/150-160¹⁾	1	60-70
Ring cake		300-325/150-160	2²⁾	50-60
		325-340/160-170	1	60-70

 Function /  Convection Bake /  Surround

 Temperature / ⁵₁ Shelf level /  Duration

- 1) Preheat the oven. Do not use the Booster function  for this.
- 2) If you are using FlexiClip runners (depending on model), fit them one level lower.
- 3) Take the baking trays out of the oven early if the food is sufficiently browned before the specified duration has elapsed.

Creamed mixture

Cakes/ biscuits		 [°F/°C]	 ⁵ ₁	 [min]
Foam cake (tray)		300-325/150-160	2 ²⁾	25-35
		300-325/150-160 ¹⁾	2 ²⁾	30-40
Marble, nut cake (tin)		300-325/150-160	2 ²⁾	55-75
		300-325/150-160	1	55-75
Fresh fruit cake, with meringue topping/glaze (tray)		300-325/150-160	2 ²⁾	40-50
		325-340/160-170	2 ²⁾	45-55
Fresh fruit cake (tray)		300-325/150-160	2 ²⁾	35-45
		325-340/160-170	2 ²⁾	35-55
Fresh fruit cake (tin)		300-325/150-160	2 ²⁾	55-65
		340-350/170-180	1	35-45
Flan base		300-325/150-160	2 ²⁾	25-35
		340-350/170-180 ¹⁾	2 ²⁾	15-25

















 Function /  Convection Bake /  Surround

 Temperature /  Shelf level /  Duration

- 1) Preheat the oven. Do not use the Booster function  for this.
- 2) If you are using FlexiClip runners (depending on model), fit them one level lower.

Baking

Rubbed-in mixture















Cakes/ biscuits		 [°F/°C]	 ⁵ ₁	 [min]
Small cakes/biscuits (1 tray)		275-300/140-150	2 ²⁾	20-30
		325-340/160-170 ¹⁾	3 ²⁾	15-25
Small cakes/biscuits (2 trays)		275-300/140-150	1+3 ²⁾	20-30 ³⁾
Drop cookies (1 tray)		275/140	2	30-40
		325/160 ¹⁾	3	15-25
Drop cookies (2 trays)		275/140	1+3	35-45 ³⁾
Flan base		300-325/150-160	2 ²⁾	35-45
		340-350/170-180 ¹⁾	2 ²⁾	20-30
Streusel cake		300-325/150-160	2 ²⁾	45-55
		340-350/170-180	2 ²⁾	45-55
Cheesecake		300-325/150-160	2 ²⁾	70-80
		340-350/170-180	1	80-90
		300-325/150-160	2 ²⁾	70-80

 Function /  Convection Bake /  Surround /  Intensive



 Temperature / ⁵ Shelf level /  Duration

- 1) Preheat the oven. Do not use the Booster function  for this.
- 2) If you are using FlexiClip runners (depending on model), fit them one level lower.
- 3) Take the baking trays out of the oven early if the food is sufficiently browned before the specified duration has elapsed.

Rubbed-in mixture

Cakes/ biscuits		 [°F/°C]	 ⁵ ₁	 [min]
Apple cake (baking tin Ø 20 cm)		325/160	2	90–100
		340/170	1	90–100
Apple pie		325–340/160–170	2 ²⁾	50–70
		340–350/170–180 ¹⁾	1	60–70
		325–340/160–170	2 ²⁾	50–70
Fresh fruit cake, glazed (tin)		300–325/150–160	2 ²⁾	55–75
		340–350/170–180	1	55–75
		300–325/150–160	2 ²⁾	55–65
Swiss apple pie (tray)		425–450/220–230 ¹⁾	1	30–50
		350–375/180–190	1	30–50















 Function /  Convection Bake /  Surround /  Intensive

 Temperature / ⁵₁ Shelf level /  Duration

- 1) Preheat the oven. Do not use the Booster function  for this.
- 2) If you are using FlexiClip runners (depending on model), fit them one level lower.

Baking

Yeast and quark doughs

















Cakes/ biscuits		 [°F/°C]	 ⁵ ₁	 [min]
Gugelhupf		300-325/150-160	2 ¹⁾	50-60
		325-340/160-170	1	50-60
Stollen		300-325/150-160	2 ¹⁾	45-65
		325-340/160-170	2 ¹⁾	45-60
Streusel cake		300-325/150-160	2 ¹⁾	35-45
		340-350/170-180	2 ¹⁾	35-45
Fresh fruit cake (tray)		325-340/160-170	2 ¹⁾	40-50
		325-340/160-170	2 ¹⁾	45-55
Apple turnovers (1 tray)		300-325/150-160	2 ¹⁾	25-30
		325-340/160-170	2 ^{1) 2)}	25-30
Apple turnovers (2 trays)		300-325/150-160	1+3 ¹⁾	25-30 ³⁾

 Function /  Convection Bake /  Surround



 Temperature / ⁵₁ Shelf level /  Duration



- 1) If you are using FlexiClip runners (depending on model), fit them one level lower.
- 2) For yeast dough. For quark dough use shelf level 3.
- 3) Take the baking trays out of the oven early if the food is sufficiently browned before the specified duration has elapsed.

Yeast and quark doughs

Cakes/ biscuits		 [°F/°C]	 ⁵ ₁	 [min]
White bread		350–375/180–190	2 ²⁾	35–45
		375–400/190–200	2 ²⁾	30–40
Wholegrain bread		350–375/180–190	2 ²⁾	55–65
		400–410/200–210 ¹⁾	2 ²⁾	45–55
Pizza (tray)		340–350/170–180	2 ²⁾	35–45
		375–400/190–200 ¹⁾	2 ^{2) 3)}	30–45
		340–350/170–180	2 ^{2) 3)}	35–45
Onion tart		340–350/170–180	2 ²⁾	35–45
		350–375/180–190 ¹⁾	2 ^{2) 3)}	25–35
		340–350/170–180	2 ²⁾	30–40
Proving dough		75/30	4)	15–30
		75/30	4)	15–30













 Function /  Convection Bake /  Surround /  Intensive

 Temperature /  Shelf level /  Duration



- 1) Preheat the oven. Do not use the Booster function  for this.
- 2) If you are using FlexiClip runners (depending on model), fit them one level lower.
- 3) For yeast dough. For quark dough use shelf level 3.
- 4) The dish can be placed on the oven floor. Depending on the size of the dish, you may need to remove the side runners. If using Surround , please also place the rack on the oven floor.

Baking

Sponge mix













Cakes/ biscuits		 [°F/°C]	 ⁵ ₁	 [min]
Tart / flan base (2 eggs)		325–340/160–170	2 ²⁾	20–30
		325–340/160–170 ¹⁾	2²⁾	15–25
Sponge cake (4–6 eggs)		340–350/170–180	2 ²⁾	20–35
		300–325/150–160 ¹⁾	1	30–45
Whisked sponge		340/170	2	30–40
		300–340/150–170 ¹⁾	1	30–45
Swiss roll		340–350/170–180 ¹⁾	2 ²⁾	10–20
		350–375/180–190 ¹⁾	2²⁾	10–15

 Function /  Convection Bake /  Surround



 Temperature / ⁵₁ Shelf level /  Duration

- 1) Preheat the oven. Do not use the Booster function  for this.
- 2) If you are using FlexiClip runners (depending on model), fit them one level lower.

Choux pastry, puff pastry, meringue

Cakes/ biscuits		 [°F/°C]	 ⁵ ₁	 [min]
Choux buns (1 tray)		325–340/160–170	2 ²⁾	30–45
		350–375/180–190 ¹⁾	2 ²⁾	25–35
Choux buns (2 trays)		325–340/160–170	1+3 ²⁾	30–45 ³⁾
Puff pastry (1 tray)		340–350/170–180	2 ²⁾	20–30
		375–400/190–200	3 ²⁾	20–30
Puff pastry (2 trays)		340–350/170–180	1+3 ²⁾	20–30 ³⁾
Macaroons (1 tray)		250–265/120–130	2 ²⁾	25–50
		250–265/120–130 ¹⁾	2 ²⁾	25–45
Macaroons (2 trays)		250–265/120–130	1+3 ²⁾	25–50 ³⁾

 Function /  Convection Bake /  Surround



 Temperature / ⁵₁ Shelf level /  Duration

- 1) Preheat the oven. Do not use the Booster function  for this.
- 2) If you are using FlexiClip runners (depending on model), fit them one level lower.
- 3) Take the baking trays out of the oven early if the food is sufficiently browned before the specified duration has elapsed.

Roasting

Always follow USDA guidelines on food safety.

Operating modes

Depending on how the food is prepared, you can use either Convection Bake  or Surround .

Containers

You can use any heat-resistant containers:

Oven dishes, roasting pans, ovenproof glass dishes, roasting bags, dishes made from earthenware or cast iron, the universal tray, rack and/or anti-splash insert (if available) on top of the universal tray.

We recommend roasting in a covered oven dish, as this will ensure that enough stock will be prepared to make gravy.

The oven will also stay cleaner than when roasting on the rack.



Tips

- Browning: Browning only occurs towards the end of the roasting time. Remove the lid about halfway through the roasting time if a more intensive browning result is desired.
- Standing time: At the end of the program, take the roast out of the oven, wrap in aluminium foil and leave to stand for about 10 minutes. This helps retain juices when the meat is carved.
- Roasting poultry: For a crisp skin, baste the poultry 10 minutes before the end of the cooking time with slightly salted water.

Notes on using the roasting charts

In the charts the data for the recommended function is printed in bold. Unless otherwise stated, the durations given are for an oven which has not been preheated. With a preheated oven, shorten times by around 10 minutes.

Temperature

As a general rule, select the lower temperature given in the chart. If higher temperatures are used, the meat will brown on the outside, but will not be properly cooked through. When cooking with Convection Bake , select a temperature 40 °F/20 °C lower than when using Surround .

Preheating

Preheating is generally only required when roasting beef sirloin joints and fillet.

Roasting duration

The roasting time can be determined by multiplying the thickness of the roast [cm] with the time per cm [min./cm] stated below, depending on the type of meat:

- Beef/Venison: 15–18 min./cm
 - Pork/Veal/Lamb: 12–15 min./cm
 - Sirloin joints/Fillets: 8–10 min./cm
- Roasting times are approx. 20 minutes longer per kilo for frozen meat. Frozen meat weighing less than approx. 1.5 kg does not need to be defrosted before roasting.













As a general rule, check the food after the shortest duration.





Shelf level

As a general rule, use shelf level 2. If you are using FlexiClip runners (depending on model), fit them one level lower.

Roasting charts

Beef, veal

		 [°F/°C]	 5 1 *	 [min]
Topside of beef, approx. 1 kg		340–350/170–180	2	100–130 ³⁾
		375–400/190–200	2	110–140 ³⁾
Fillet of beef approx. 1 kg ¹⁾		300–325/150–160 ²⁾	2	20–50 ⁴⁾
		350–375/180–190 ²⁾	2	20–50 ⁴⁾
Sirloin joint, approx. 1 kg ¹⁾		300–325/150–160 ²⁾	2	30–60 ⁴⁾
		350–375/180–190 ²⁾	2	30–60 ⁴⁾
Veal, approx. 1.5 kg		375–400/190–200	2	70–90 ³⁾
		400–410/200–210	2	90–110 ³⁾

 Function /  Temperature /  Shelf level /  Cooking duration

 Convection Bake /  Surround

* If you are using FlexiClip runners (depending on model), fit them one level lower.

- 1) Use the universal tray. Sear the meat on the cooktop first.
- 2) Preheat the oven. Do not use the Booster function  for this.
- 3) Roast with the lid on first. Remove the lid halfway through the cooking duration and add approx. 0.5 l of liquid.
- 4) Depending on desired degree of cooking (when using a separate roast probe):
 rare: 105–115 °F/40–45 °C
 medium: 120–140 °F/50–60 °C
 well done: 140–160 °F/60–70 °C

Roasting

Pork

		[°F/°C]	5 1 *	[min]
Pork joint, approx. 1 kg		340–350/170–180	2	100–120 ¹⁾
		375–400/190–200	2	90–110 ¹⁾
Pork joint with crackling, approx. 2 kg		340–350/170–180	2	120–160 ²⁾
		375–400/190–200	2	130–150 ²⁾
Gammon joint, approx. 1 kg		300–325/150–160	2	60–80 ²⁾
		340–350/170–180	2	80–100 ²⁾
Meat loaf, approx. 1 kg		340–350/170–180	2	60–70 ²⁾
		400–410/200–210	2	70–80 ²⁾

Function / Temperature / Shelf level / Cooking duration

Convection Bake / Surround

* If you are using FlexiClip runners (depending on model), fit them one level lower.

- 1) Roast with the lid on first. Remove the lid halfway through the cooking duration and add approx. 0.5 l of liquid.
- 2) Add approx. 0.5 l of liquid halfway through roasting.

Lamb, venison

		[°F/°C]	5 1 *	[min]
Leg of lamb, approx. 1.5 kg		340–350/170–180	2	90–110 ¹⁾
		350–375/180–190	2	90–110 ¹⁾
Saddle of lamb, approx. 1.5 kg		425–450/220–230 ²⁾	3	40–60 ³⁾
		450–475/230–240 ²⁾	3	40–60 ³⁾
Venison, approx. 1 kg		400–410/200–210	2	80–100 ¹⁾
		400–410/200–210	2	80–100 ¹⁾















Function / Temperature / Shelf level / Cooking duration

Convection Bake / Surround

* If you are using FlexiClip runners (depending on model), fit them one level lower.

- 1) Roast with the lid on first. Remove the lid halfway through the cooking duration and add approx. 0.5 l of liquid.
- 2) Preheat the oven. Do not use the Booster function for this.
- 3) Add approx. 0.5 l of liquid halfway through roasting.

Poultry, fish

		 [°F/°C]	 ⁵ *	 [min]
Poultry, 0.8–1 kg		350–375/180–190	2	60–70
		375–400/190–200	2	60–70
Poultry, approx. 2 kg		350–375/180–190	2	90–110
		375–400/190–200	2	110–120
Poultry, stuffed, approx. 2 kg		350–375/180–190	2	110–130
		375–400/190–200	2	110–130
Poultry, approx. 4 kg		325–340/160–170	2	120–160 ¹⁾
		350–375/180–190	2	120–160 ¹⁾
Fish, whole, approx. 1.5 kg		325–340/160–170	2	45–55
		350–375/180–190	2	45–55

 Function /  Temperature / ⁵ Shelf level /  Cooking duration

 Convection Bake /  Surround

* If you are using FlexiClip runners (depending on model), fit them one level lower.

1) Add approx. 0.5 l of liquid halfway through roasting.

Slow Roasting

This cooking method is ideal for cooking beef, pork, veal or lamb when a tender result is desired.

First briefly sear the meat all over at a high temperature on the cooktop in order to seal it.

Then place the meat in the preheated oven where the low temperature and long cooking duration will cook it to perfection and ensure it is very tender.

The meat will relax and the juices inside will start to circulate evenly throughout the meat to reach the outer layers. This will give very tender and succulent results.

Tips

- Use lean meat which has been correctly hung and trimmed. Bones should be removed before cooking.
- For searing, use a suitable cooking oil or fat that can withstand high temperatures (e.g. clarified butter).
- Do not cover the meat during cooking.

The cooking duration is approx. 2–4 hours and depends on the weight and size of the meat, as well as the desired degree of doneness and browning.

Procedure

Use the universal tray with the rack placed on top of it.

Do not use the Booster function  to preheat the oven.

- Place the rack together with the universal tray on shelf level 2.
- Select Surround  and a temperature of 265 °F/130 °C.
- Preheat the oven together with the universal tray and rack for approx. 15 minutes.
- While the oven is preheating, sear the meat on all sides on the cooktop.

 **Danger of burning!**
Wear oven gloves when placing food in the oven or removing it and when adjusting oven shelves etc. in a hot oven.

- Place the seared meat on the rack.
- Reduce the temperature to 210 °F/100 °C.
- Continue cooking until the end of the cooking duration.



On models with a clock/timer, you can set the cooking process to finish automatically (see “Clock/timer – Setting the cooking duration”).

After cooking

Because the temperature during the cooking process was so low:

- Meat can be carved straight from the oven. It does not need to rest.
- The cooking result will not be affected if the meat is left in the oven after the program has finished. It can be kept warm until you serve it.
- The meat is an ideal temperature to eat straight away. Serve on preheated plates with very hot sauce or gravy to prevent it cooling down too quickly.

Cooking durations/core temperatures

Meat	 [min]	 [°F/°C]
Fillet of beef	80–100	138/59
Sirloin of beef		
– rare	50–70	118/48
– medium	100–130	135/57
– well done	160–190	156/69
Pork fillet	80–100	145/63
Gammon *	140–170	154/68
Veal fillet	80–100	140/60
Saddle of veal *	100–130	145/63
Saddle of lamb *	50–80	140/60

 Cooking duration

Core temperature

 If you have a separate roast probe, you can use the core temperature shown.

* Boneless

Broiling



Danger of burning!

If you broil with the door open the hot air will escape from the oven before it has been cooled by the cooling fan. The controls will get hot. Broil with the oven door closed.

Operating modes

Maxi Broil

For broiling thin cuts of meat and browning.

The entire browning/broiling element will become red hot to produce the necessary heat.

Convection Broil

For broiling thicker items, such as chicken.

Containers

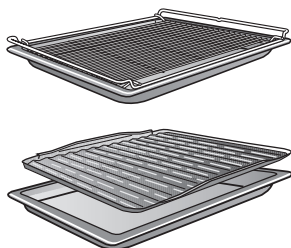

Use the universal tray with the rack or anti-splash insert on top (if available). The anti-splash insert collects the meat juices and stops them burning so they can be used to make gravy and sauces.

Do not use the baking tray.

Preparing food for broiling

Trim the meat. Do not season the meat with salt before broiling, as this will draw out the juices.

Add a little oil to lean meat if necessary. Do not use other types of fat as they can easily burn and cause smoke.

Clean fish as usual. To enhance the flavour, salt or lemon can be added.

Broiling

- Place the rack or the anti-splash insert (if available) on the universal tray.
- Place the food on it.
- Select the required oven function and the temperature.
- Preheat the browning/broiling element for approx. 5 minutes with the door closed.



Danger of burning!

Wear oven gloves when placing food in the oven or removing it and when adjusting oven shelves etc. in a hot oven.

- Place the food on the appropriate shelf level (see the broiling chart).
- Close the door.
- Turn the food halfway through broiling.

Notes on using the broiling chart

The data for the recommended function is printed in bold.

Check the food after the shortest time quoted.

Take note of the temperature range, the shelf levels and the durations. These take the size of the meat and cooking practices into account.

Temperature

As a general rule, select the lower temperature given in the chart.

If higher temperatures are used, the meat will brown on the outside, but will not be properly cooked through.

Preheating

Preheating is necessary when broiling. Preheat the browning/broiling element for approx. 5 minutes with the door closed.

Shelf level

Select the shelf level according to the thickness of the food.

- Thinner cuts: shelf level 4 or 5
- Thicker cuts: shelf level 2 or 3

Broiling duration

- Thinner cuts of meat/slices of fish require approx. 6–8 minutes per side. Thicker pieces require more time per side. It is best to broil food of a similar thickness at the same time so that the broiling time does not vary too much.
- Turn the food halfway through broiling.

Testing to see if cooked







Always follow USDA guidelines for safe food temperatures.





Useful tip: If the surface of a thicker cut of meat is browned but the centre is still raw, move the food to a lower level or reduce the temperature and continue cooking. This will stop the surface from becoming too dark.

Broiling

Broiling chart

Preheat the browning/broiling element for approx. 5 minutes with the door closed.

Food to be broiled	 5 1				
		 [°F/°C]	 [min]	 [°F/°C]	 [min]
Thin cuts					
Burgers	5 ¹⁾	500/250	25–35	–	–
Kebabs	5	500/250	10–15	475/240	12–17
Chicken kebabs	5	500/250	10–15	475/240	12–17
Pork chops	5 ¹⁾	500/250	15–25	500/250	17–23
Liver	4 ²⁾	500/250	8–12	500/250	12–15
Patties	5 ¹⁾	500/250	15–25	500/250	20–30
Sausages	5	500/250	8–15	475/240	10–15
Fish fillet	4 ²⁾	500/250	15–25	500/250	15–25
Trout	4 ²⁾	500/250	15–25	500/250	15–25
Toast	3	500/250	4–8	–	–
Hawaii toast	4 ²⁾	500/250	6–10	475/240	10–13
Tomatoes	4 ²⁾	500/250	10–15	500/250	12–17
Peaches	3/4 ²⁾	500/250	7–12	475/240	10–15
Thicker cuts					
Chicken, approx. 1.2 kg	2 ²⁾	500/250	55–65	375/190	55–65
Pork knuckle, approx. 1 kg	2 ²⁾	–	–	350/180	80–90

 Maxi Broil,  Convection Broil,  Shelf level /  Temperature /  Duration

- 1) Place the rack on shelf level 5 and the universal tray on shelf level 2.
- 2) If you are using FlexiClip runners (depending on model), fit them one level lower.

Defrost

To gently defrost food use the Defrost  mode with 70–120 °F/25–50 °C.

When this mode is selected, the fan turns on and circulates the air around the oven cavity.

 **Danger of salmonella poisoning!**
Observe proper hygiene rules when defrosting poultry.
Do not use the defrosting liquid.

Tips

- If possible, remove the packaging and put the food on the roasting pan or a suitable dish.
- When defrosting poultry catch the defrosting liquid in a suitable dish.

Heating dishes

Use Convection Bake  for preheating dishes.

Only preheat heat-resistant dishes.

- Place the rack on shelf level 2 and place the dishes to be preheated on it. Depending on the size of the dishes, you can also place it on the oven floor and take the side runners out to make more room.
- Select Convection Bake .
- Set the temperature to 120–175 °F/50–80 °C.

 **Danger of burning!**
Use oven gloves when removing dishes from the oven. Droplets of water may have accumulated underneath the dish.

- Remove the heated dishes from the oven.

Further applications

Eco-Convection



Eco-Convection  is suitable for small amounts, e.g. frozen pizzas, bake-off rolls, biscuits and for meat dishes and roasts. The optimal use of heat enables energy savings of up to 30 % to be made compared to cooking with a standard oven function with comparatively good cooking results.



This function is not suitable for larger amounts of food such as sponge cakes and fresh fruit cake where the cake mix needs to be thoroughly baked throughout. No energy savings would be achieved in this case.

The oven lighting does not switch on in this function.

For optimum savings in energy usage keep the door shut whilst cooking.

Examples of use:

Food	 [°F/°C]	 [min]
Biscuits	325/160	22–27
Ratatouille	350/180	40–60
Fish fillet in foil approx. 500 g	400/200	25–35
Frozen pizza, precooked	410/210	20–25
Ham roast, approx. 1.5 kg	325/160	115–145
Braised beef, approx. 1.5 kg	350/180	160–180

 Temperature /  Duration

- Use shelf level 1 or 2 depending on the height of the food.
- The durations given are for an oven which has not been preheated.
- Roast with the lid on first. Then remove the lid three-quarters of the way through roasting and add approx. 0.5 l of liquid.
- Check the food after the shortest duration quoted.

Frozen food/Ready meals

Tips for pizza, French fries and similar items

- For best results place frozen pizza on parchment paper on the wire rack.
- Small frozen items such as french fries can be cooked on the baking tray or roasting pan.
- For small frozen items, use the lowest temperature recommended by the manufacturer.
- Turn small frozen items several times during cooking.

Method

Handling food carefully will help protect your health.

Cakes, pizzas and french fries should be cooked until golden, not dark brown.

- Select the oven function and temperatures recommended on the food's packaging.
- Preheat the oven.
- Place the food in the preheated oven on the shelf level recommended on the packaging.
- Check the food at the end of the shortest time recommended on the packaging.

Further applications



Drying/dehydrating





Dehydrating is a traditional method of preserving fruit, certain vegetables and herbs.



It is important that fruit and vegetables are ripe and not bruised before they are dehydrated.

- Prepare the food for drying.
 - Peel and core apples, and cut into slices ¼"/0.5 cm thick.
 - Stone plums, if necessary.
 - Peel, core and cut pears into wedges.
 - Peel and slice bananas.
 - Clean mushrooms, then either halve or slice them.
 - Remove parsley and dill from the stem.
- Distribute the food evenly over the universal tray.

You can also use the Gourmet perforated baking tray, if you have one.

- Select Convection Bake  or Surround .
- Select a temperature of 175-210 °F/80-100 °C.
- Place the universal tray on shelf level 2.
If you are using Convection Bake , you can dry produce on levels 1+3 at the same time.

Food		⌚ [min]
Fruit		120-480
Vegetables		180-480
Herbs		50-60

-  Function / ⌚ Drying time
 Convection Bake /  Surround

- Reduce the temperature if condensation begins to form in the oven.

 **Danger of burning!**
Use oven gloves when removing the food from the oven.

- Allow the fruit or vegetables to cool down after dehydrating.

Dried fruit must be completely dry, but also soft and elastic. Juice should not escape when cut.

- Store in sealed glass jars or tins.

Canning

Always follow the USDA canning guidelines.

Canning containers

 **Danger of injury!**
Heating food up in closed containers, e.g. tins or sealed jars, results in an increase in pressure which can cause them to explode. Do not use the oven for canning food or for heating up food in tins.

Only use jars designed for canning:

- Canning jars
- Jars with twist-off lids

Canning fruit and vegetables

We recommend the Convection Bake  function.

Values apply for 6 x 1 litre jars.

- Place the universal tray on shelf level 2 and place the jars on it.
- Select the Convection Bake  function and a temperature of 300–325 °F/150–160 °C.
- Wait until small bubbles are forming evenly in the jars.

Reduce the temperature in good time to prevent the contents from boiling over.

Fruit/pickles

- Turn the function selector to Oven lighting  as soon as you can see the bubbles forming in the jars. Leave the jars to stand for a further 25–30 minutes in the warm oven cavity.

Vegetables

- Reduce the temperature to 210 °F/100 °C as soon as you can see the bubbles forming in the jars.

	 [min]
Carrots	50–70
Asparagus, peas, beans	90–120

 Canning duration

- When the canning duration has elapsed turn the function selector to Oven lighting . Leave the jars to stand for a further 25–30 minutes in the warm oven cavity.

After canning

 **Danger of burning!**
Use oven gloves when removing the jars from the oven.

- Take the jars out of the oven.
- Cover the jars with a towel and leave to set for approx. 24 hours.
- Make sure all jars are closed properly when storing them.

Cleaning and care



Danger of burning!

Make sure the oven heating elements are switched off. The oven must be cool.



Danger of injury!

The steam from a steam cleaning appliance could reach electrical components and cause a short circuit.

Do not use a steam cleaner to clean this appliance.

The use of unsuitable cleaning agents can discolour or alter the external surfaces of the oven. The oven front is particularly susceptible to damage from oven cleaners. All surfaces are susceptible to scratching. Scratches on glass can in some circumstances lead to breakage. Remove all cleaning agent residues immediately.

- glass cleaning agents
- cleaning agents for ceramic cooktops
- hard, abrasive brushes or sponges, (e.g. pot scourers, brushes or sponges which have been previously used with abrasive cleaning agents)
- eraser blocks
- sharp metal scrapers
- wire wool
- spot cleaning with mechanical cleaning agents
- oven cleaner
- stainless steel spiral pads

If soiling is left on for any length of time, it may become impossible to remove. If items are used frequently without being cleaned, it may become very difficult to clean them.

Soiling is best removed after each use of the oven.

The accessories are not dishwasher-safe.

Unsuitable cleaning agents

To avoid damaging the surfaces, do not use:

- cleaning agents containing soda, ammonia, acids or chlorides
- cleaning agents containing descaling agents on the oven front
- abrasive cleaning agents (e.g. scouring powder, scouring cream, bath bricks)
- solvent-based cleaning agents
- stainless steel cleaning agents
- dishwasher cleaner

Tips

- Soiling such as spilt juices and cake mixtures are best removed whilst the oven or tray is still warm.
- To make cleaning easier you can dismantle the oven door, remove the side runners and the FlexiClip runners (if present), remove the catalytic back panel and lower the browning/broiling element.

Normal soiling

See “Cleaning catalytic enamelled panels” for instructions on how to keep catalytic panels clean.

- Remove normal soiling immediately with warm water, liquid dish soap and a clean sponge or a clean, damp microfibre cloth.
- Remove all cleaning agent residues thoroughly with clean water. This is particularly important for any parts with a PerfectClean finish, as cleaning agent residues will impair the non-stick function.
- After cleaning, wipe the surfaces dry using a soft cloth.

Cleaning the seal

There is a seal around the oven cavity which seals the oven cavity and the inside of the door.

Grease deposits on the seal can cause it to become brittle and cracked.

- It is advisable to wipe the seal clean after each use.

Stubborn soiling (excluding the FlexiClip runners)

Spilt fruit and roasting juices may cause lasting discolouration or dull patches on enamelled surfaces. This discolouration is permanent but will not affect the efficiency of the finish. Do not use force to remove stains. Clean only as described in this manual.

- Baked-on deposits can be removed with a glass scraper or with a non-abrasive stainless steel spiral pad, warm water and liquid dish soap.

Oven cleaners will damage the catalytic enamelled surfaces. Remove the catalytic enamelled panels before using an oven cleaner.

- For very persistent soiling on PerfectClean coated enamel, apply the Miele oven spray to cold surfaces. Follow the instructions on the packaging.

Non-Miele oven cleaner must only be used in a cold oven and for no longer than a maximum of 10 minutes.

- You can then also use the scouring pad on the back of a washing-up sponge to remove the soiling.
- After cleaning, remove all oven cleaning agent residues thoroughly with clean water, and dry with a soft cloth.

Stubborn soiling on the FlexiClip runners

Do not wash the FlexiClip runners in the dishwasher. This will remove the special lubricant which is essential for their smooth functioning.

For stubborn surface soiling or if the bearings become sticky, proceed as follows:

- Soak the FlexiClip runners briefly (approx. 10 minutes) in a solution of hot water and liquid dish soap.

Cleaning and care

If necessary, you can also use the scouring pad on the back of a washing-up sponge. You can clean the bearings with a soft brush.

After cleaning discolourations or lighter areas may remain on the runners. This will not affect the performance in any way.

Cleaning catalytic enamelled panels

Soiling from oil and fat is burnt off catalytic enamel when very high temperatures are used in the oven.

The higher the temperature, the more effective the process.

Exposure to scouring agents, abrasive brushes or sponges and oven cleaner can cause catalytic enamel to lose its self-cleaning properties.
Remove the catalytic enamelled panels before using an oven cleaner.

Removing soiling caused by spices, sugar and similar deposits

- Remove the back panel (see “Cleaning and care – Removing the back panel”).
- Wash the back panel by hand with warm water and liquid dish soap applied with a soft brush.
- Rinse the back panel thoroughly. Let it dry before placing it back in the oven.

Removing oil and grease

- Remove any accessories from the oven, including the side runners.
- Before starting the cleaning process, remove any large deposits of soiling from the inside of the door and the PerfectClean surfaces to prevent them burning on.
- Select the Convection Bake  function and a temperature of 475 °F/250 °C.
- Then heat the empty oven for at least 1 hour.
The length of time required will depend on the level of soiling.

If the catalytic coating is very heavily soiled with oil and grease, a film can form on the surfaces of the oven cavity during the cleaning process.

 Danger of burning! Allow the oven cavity to cool down before cleaning by hand.

- Clean the inside of the door and the oven cavity with warm water and liquid dish soap, applied with a clean sponge cloth or a clean, damp microfibre cloth.

Any remaining soiling will gradually disappear with each subsequent use of the oven at a high temperature.

Removing the door

The door weighs approx. 9 kg.

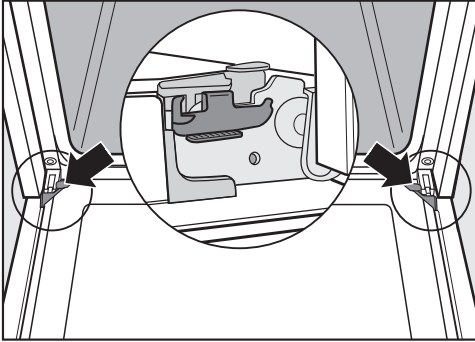

The oven door is connected to the hinges by retainers. Before removing the door from the retainers, the locking clamps on both hinges have to be released.

- Open the door fully.

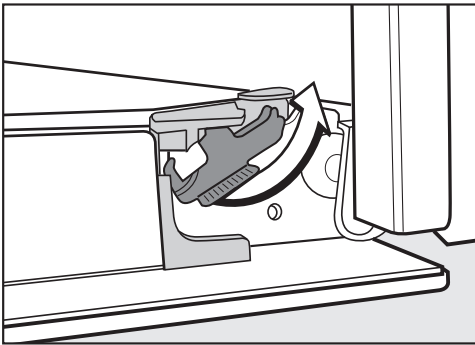

- Release the locking clamps by turning them as far as they will go.

Do not pull the door horizontally off its retainers, as they will spring back against the oven.

Do not pull the door off the retainers by the handle, as the handle could break off.

- Close the door to the point where resistance is felt when it is almost closed.



- Hold the door on either side and pull it upwards off the hinge retainers. Make sure that you do not tilt the door.

Cleaning and care

Reinstalling the door

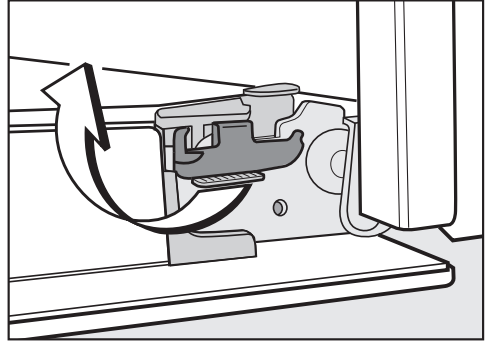
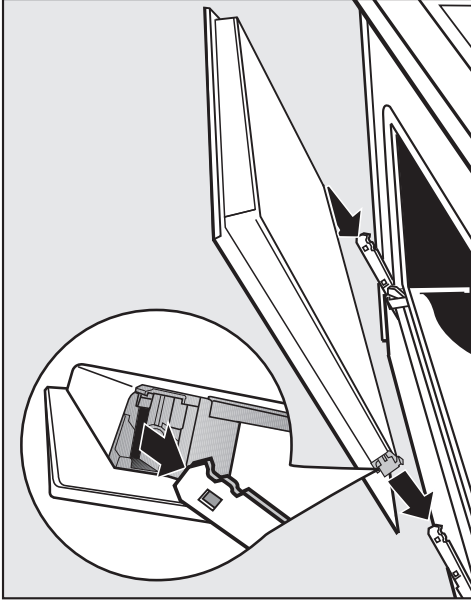

- To relock the locking clamps, turn them back up to the horizontal position as far as they will go.

- Hold the door securely on both sides and carefully fit it back into the hinge retainers. Make sure that you do not tilt the door.
- Open the door fully.

If the locking clamps are not locked, the door could work loose resulting in damage.

Ensure that the locking clamps are locked after refitting the door.

Removing the side runners with FlexiClip runners

The side runners can be removed together with the FlexiClip runners (if inserted).

If you wish to remove the FlexiClip runners separately beforehand, please follow the instructions in “Features – Fitting and removing FlexiClip runners”.

⚠ Danger of burning!
Make sure the oven heating elements are switched off. The oven must be cool.

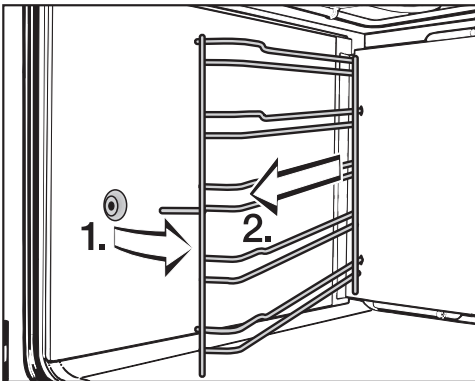

- Pull the side runners out of the holder (1.) and remove them (2.).

Reassemble by following these instructions in reverse order.

- Insert the components carefully.

Removing the back panel

⚠ Danger of injury!
Do not use the oven without the back panel in place.

The back panel can be removed for cleaning purposes.

⚠ Danger of burning!
Make sure the oven heating elements are switched off. The oven must be cool.

- Disconnect the appliance from the power supply. Switch off at the wall and withdraw the plug from the socket, or switch off at the circuit breaker.
- Remove the side runners.
- Undo the four screws in the corners of the back panel and take it out.
- Clean the back panel (see “Cleaning and Care – Cleaning catalytic enamelled panels”).

Reassemble by following these instructions in reverse order.

- Refit the back panel carefully.

Make sure the openings are located as illustrated in “Oven overview”.

- Refit the side runners.
- Reconnect the appliance to the power supply.

Cleaning and care

Lowering the browning/broiling element

 **Danger of burning!**
Make sure the oven heating elements are switched off. The oven must be cool.

- Remove the side runners.

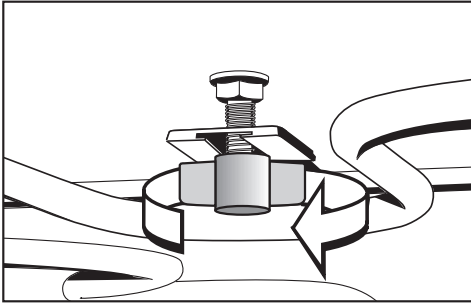

- Unscrew the wing nut.

Take care not to damage the browning/broiling element.
Do not use force when lowering the browning/broiling element.

- Carefully lower the browning/broiling element.

The oven ceiling can now be cleaned.



- Raise the browning/broiling element and tighten the wing nut securely.
- Refit the side runners.

Problem solving guide



Many malfunctions and errors that can occur in daily operation can be easily remedied. You can save time and money in many cases, as you do not need to contact Miele Customer Service.

Information to help you rectify malfunctions yourself can be found at www.miele.com/service.



The following tables are designed to help you to find the cause of a malfunction or an error and to resolve it.

Problem	Possible cause and solution
The display is dark.	<p>There is no power to the oven.</p> <ul style="list-style-type: none"> ■ Check that the oven's electrical plug is correctly inserted in the socket and that the socket switch has been switched to on. ■ Check if the circuit breaker has tripped. If it has, contact a qualified electrician or Miele Customer Service.
The oven does not heat up.	<p>The system lock  has been activated.</p> <ul style="list-style-type: none"> ■ Turn the system lock off (see "Clock/timer – Changing settings").
	<p>There is no power to the oven.</p> <ul style="list-style-type: none"> ■ Check whether the mains fuse has tripped. Contact a qualified electrician or Miele Service.
The oven does not heat up.	<p>You have only selected an oven function or a temperature.</p> <ul style="list-style-type: none"> ■ Select a function and a temperature.
	<p>The system lock  has been activated.</p> <ul style="list-style-type: none"> ■ Turn the system lock off (see "Clock/timer – Changing settings").
	<p>There is no power to the oven.</p> <ul style="list-style-type: none"> ■ Check whether the mains fuse has tripped. Contact a qualified electrician or Miele Service.
12:00 is flashing in the display.	<p>There has been a power failure.</p> <ul style="list-style-type: none"> ■ Reset the time of day (see "Before using for the first time"). Cooking times will also need to be reset.

Problem solving guide

Problem	Possible cause and solution
<p>0:00 appears unexpectedly in the display and  is flashing at the same time. The buzzer might also be sounding.</p>	<p>The oven has been operating for an unusually long period of time, and this has activated the safety shut-off.</p> <ul style="list-style-type: none"> ■ Turn the function selector to 0. The oven is now ready to use again immediately.
<p>F XX appears in the display.</p>	<p>A fault has occurred that you cannot resolve.</p> <ul style="list-style-type: none"> ■ Contact Miele Service.
<p>A noise is heard after the cooking process is complete.</p>	<p>The cooling fan will continue to run for a while after the oven has been switched off to prevent any humidity building up in the oven, on the control panel or in the cabinet carcass.</p> <p>The cooling fan will switch itself off automatically after a certain period of time.</p>
<p>Spots appear on the catalytic surfaces.</p>	<p>The catalytic cleaning process does not remove spices, sugar or similar deposits.</p> <ul style="list-style-type: none"> ■ Take catalytic panels out of the oven and remove this type of deposit with warm water and liquid dish soap applied with a soft brush (see “Cleaning catalytic enamelled panels”).
<p>Cakes and biscuits are not baked properly after following the times given in the baking chart.</p>	<p>A different temperature than that given in the recipe was used.</p> <ul style="list-style-type: none"> ■ Select the temperature required for the recipe.
	<p>The ingredient quantities are different from those given in the recipe.</p> <ul style="list-style-type: none"> ■ Check if you have amended the recipe. The addition of more liquid or more eggs will make a wetter mixture which will take longer to cook.
<p>The browning is uneven.</p>	<p>The wrong temperature or shelf level was selected.</p> <ul style="list-style-type: none"> ■ There will always be a slight unevenness. If browning is very uneven, check whether the correct temperature and shelf level were selected.
	<p>The material or colour of the bakeware is not suitable for the oven function selected.</p> <ul style="list-style-type: none"> ■ When using Surround  use matt, dark coloured tins. Light coloured, shiny tins will not produce as desirable results.

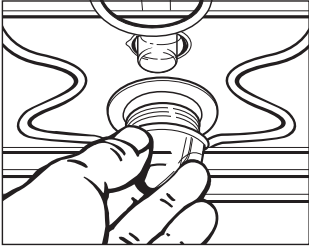
Problem solving guide

Problem	Possible cause and solution
<p>The FlexiClip runners do not push in or pull out smoothly.</p>	<p>The bearings in the FlexiClip runners are not sufficiently lubricated.</p> <ul style="list-style-type: none"> ■ Lubricate the bearings with the special Miele lubricant. <p>Only the special Miele lubricant is designed for the high temperatures in the oven cavity. Other lubricants may resinify when heated and will gum up the FlexiClip runners. You can obtain the special Miele lubricant from your Miele dealer or from Miele Service.</p>
<p>The top oven lighting does not turn on.</p> 	<p>The halogen lamp is faulty.</p> <div style="border: 1px solid black; padding: 5px; margin: 10px 0;"> <p>⚠ Danger of burning! Make sure the oven heating elements are switched off. The oven must be cool.</p> </div> <ul style="list-style-type: none"> ■ Disconnect the appliance from the power supply. Switch off at the wall and withdraw the plug from the socket, or switch off at the circuit breaker. ■ Turn the lamp cover a quarter turn counter-clockwise to release it and then pull it downwards together with its seal to take it out. ■ Replace the halogen lamp (Osram 66725 AM/A, 230 V, 25 W, G9). ■ Refit the lamp cover together with its seal and turn it clockwise to secure. ■ Reconnect the appliance to the power supply. <p>You have selected Eco-Convection . The oven lighting does not switch on in this function.</p>

Service and warranty

After-sales service

For problems that you cannot resolve on your own, please contact:

- Your Miele dealer or
- Miele Service

The telephone number for Miele Service can be found at the back of this booklet.

When contacting Miele, please have the model and serial number of your appliance ready.

This information is given on the data plate, which is visible on the front frame of the oven when the door is fully open.

For appliances with cooktop controls, also quote the model and serial number of the cooktop (see the separate operating and installation instructions included with the cooktop).

Warranty

For further information, please refer to your warranty booklet.

Installation diagrams

Appliance and cut-out dimensions

Miele ovens can be installed flush or proud. Discuss your installation requirements with your architect, designer and installer.

Undercounter installation

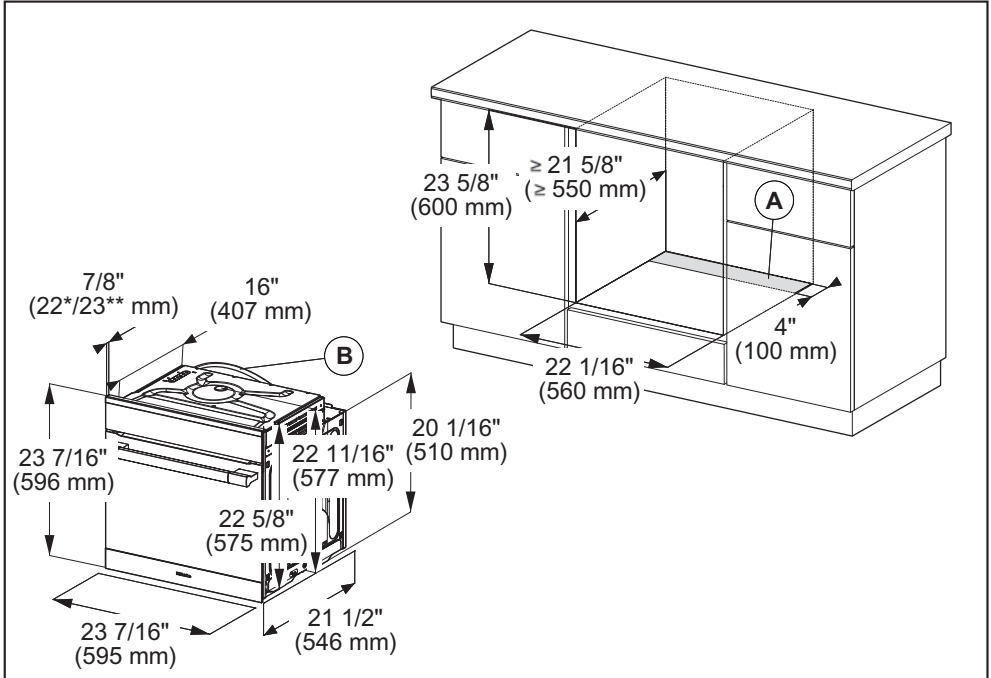

- Ⓐ Cut-out (4" x 22" / 100 mm x 560 mm) in the bottom of the cabinet for power cord and ventilation
- Ⓑ Power cord with plug

* Oven with glass front

** Oven with metal front

Front design may vary depending on model. For the more current specifications please visit the Miele website.

Installation

Installation into a tall cabinet

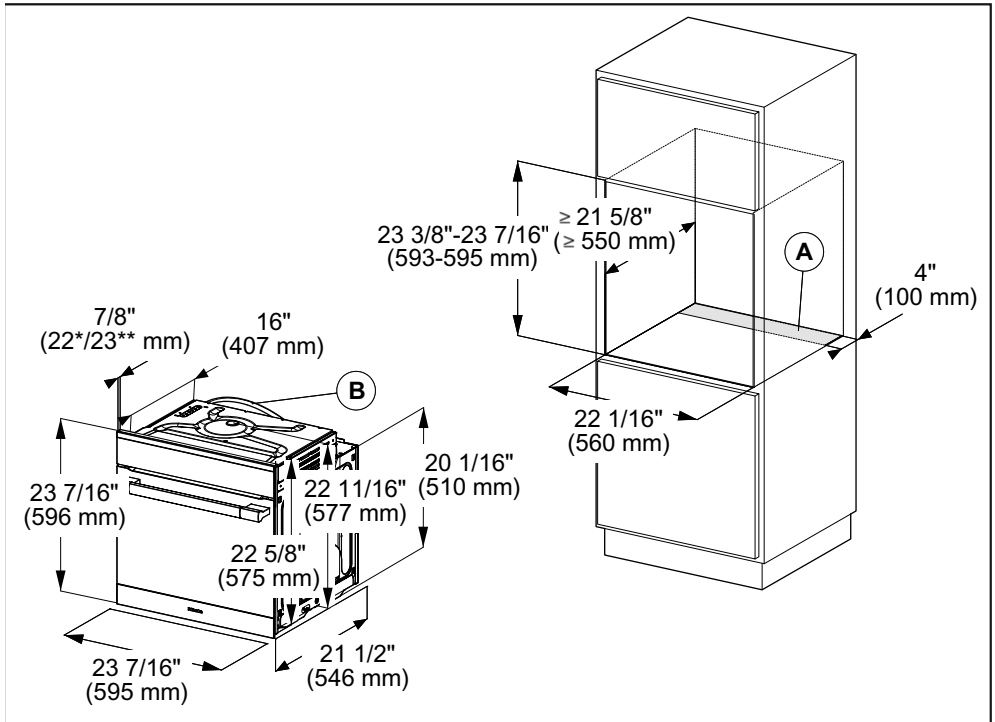

- Ⓐ Cut-out (4" x 22" / 100 mm x 560 mm) in the bottom of the cabinet for power cord and ventilation
- Ⓑ Power cord with plug
- * Oven with glass front
- ** Oven with metal front

Front design may vary depending on model. For the more current specifications please visit the Miele website.

Dimensions of oven front

Dimensions are given in mm.

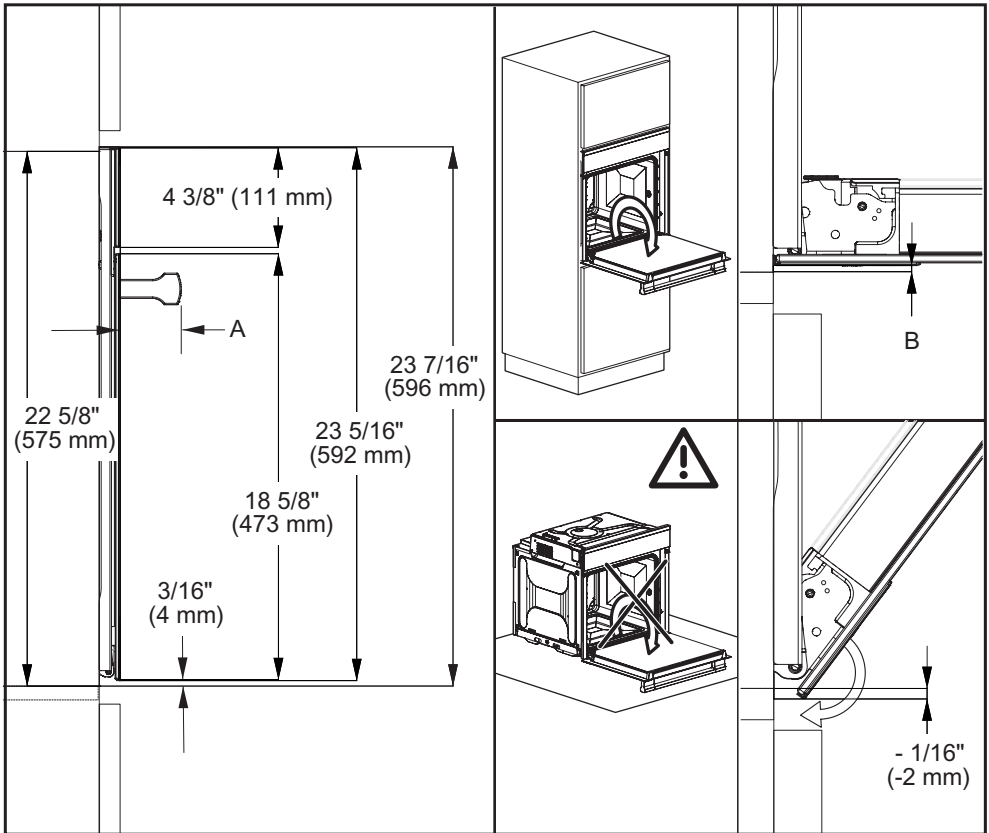

- A** H22xx: 42 mm
- B** Ovens with glass front: 2.2 mm
Ovens with metal front: 1.2 mm

Installation

Installing the cooker

 The cooker must not be operated until it has been correctly installed.

The cooker requires a sufficient supply of cool air for efficient operation. Make sure that the supply of cool air is not hindered in any way (e.g. by fitting heat insulation strips in the cabinet carcass). Furthermore the required supply of cool air must not be excessively heated by other heat sources (e.g. solid fuel stoves).

Before installation

- Ensure that there is no power to the socket.
- Please observe the wiring diagram on the cooker.

Installing the cooker

- Connect the cooker to the electrical supply.
- Place the cooker in front of the cabinet carcass.
- Insert the plug of the built-in cooktop into the connection on the cooker.

Lifting the cooker by the door handle could cause damage to the door. Use the handle cut-outs on the side of the housing to lift the appliance.

It is a good idea to remove the door (see “Cleaning and care – Removing the door”) and to remove the accessories before installing the appliance. The cooker is then easier to push into the cabinet carcass and you do not run the risk of lifting it by the door handle.

- Push the cooker into the cabinet carcass and align it.
- Open the door, if you have not removed it.

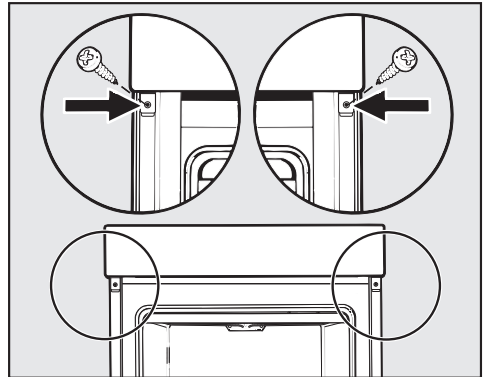

- Secure the cooker to the side walls of the cabinet carcass using the screws supplied.
- Refit the door if necessary (see “Cleaning and care – Fitting the door”).

Installing the oven

 The oven must not be operated until it has been correctly installed in the cabinet carcass.

The oven requires a sufficient supply of cool air for efficient operation. Make sure that the supply of cool air is not hindered in any way (e.g. by fitting heat insulation strips in the cabinet carcass). Furthermore the required supply of cool air must not be excessively heated by other heat sources (e.g. solid fuel stoves).

Before installation

- Ensure that there is no power to the socket.

Installing the oven

- Connect the oven to the electrical supply.

Lifting the oven by the door handle could cause damage to the door. Use the handle cut-outs on the side of the housing to lift the appliance.

It is a good idea to remove the door (see “Cleaning and care – Removing the door”) and to remove the accessories before installing the appliance. The oven is then easier to push into the cabinet carcass and you do not run the risk of lifting it by the door handle.

- Push the oven into the cabinet carcass and align it.

- Open the door, if you have not removed it.

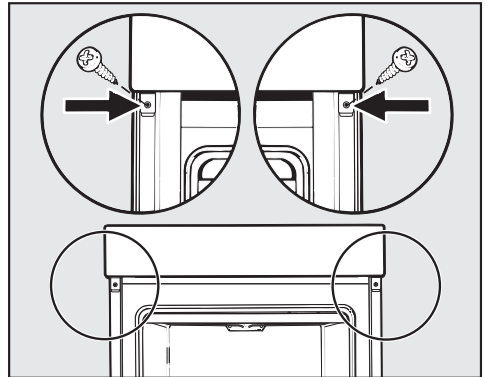

- Secure the oven to the side walls of the cabinet carcass using the screws supplied.
- Refit the door if necessary (see “Cleaning and care – Fitting the door”).

Installation

Electrical connection

 CAUTION:

Before servicing, disconnect the power supply by either removing the fuse, shutting off the power main or manually “tripping” the circuit breaker.

Installation, repair and maintenance work must be performed by a Miele authorized service technician. Work by unqualified persons could be dangerous and may void the warranty.

Before connecting the appliance to the power supply, make sure that the voltage and frequency listed on the data plate correspond with the household electrical supply. This data must correspond to prevent machine damage. Consult an electrician if in doubt.

Only operate the appliance after it has been installed into cabinetry.

The plug must be inserted into a suitable outlet that has been installed and grounded in compliance with all applicable local regulations.

WARNING: THIS APPLIANCE MUST BE GROUNDED

Installer: Please pass these instructions on to the customer.

Data plate

The silver data plate is located along the front side of the oven with the door open (see “Guide to the oven”).

 Before connecting the appliance to the power supply, make sure that the voltage and frequency listed on the data plate correspond with the household electrical supply. This data must correspond to prevent machine damage. Consult an electrician if in doubt.

H 2265-1 B

Electrical connection 208 V

 Do not connect the oven to a 240 V power supply.

The oven is equipped with a 6' 3" (1.9 m) long flexible power cord with a NEMA 14-30P plug, ready for connection to a 120/208 V, 60 Hz, 20 A power supply.

Maximum connected load: 3,600 W

Electrical connection 240 V

The oven is equipped with a 6' 3" (1.9 m) long flexible power cord with a NEMA 14-30P plug, ready for connection to a 120/240 V, 60 Hz, 20 A power supply.

Maximum connected load: 3,800 W

H 2265-1 E/H 2265-1 I

Electrical connection 208 V

 Do not connect the oven to a 240 V power supply.

The oven is equipped with a 6' 3" (1.9 m) long flexible power cord with a NEMA 14-50P plug, ready for connection to a 120/208 V, 60 Hz, 40 A power supply.

Maximum connected load: 9,700 W, in combination with a Miele cooktop.

Electrical connection 240 V

The oven is equipped with a 6' 3" (1.9 m) long flexible power cord with a NEMA 14-50P plug, ready for connection to a 120/240 V, 60 Hz, 40 A power supply.

Maximum connected load: 9,900 W, in combination with a Miele cooktop.

SAVE THESE INSTRUCTIONS FOR THE ELECTRICAL INSPECTOR'S USE.

**Please have the model and serial number
of your appliance available when
contacting Customer Service.**

**Canada
Importer
Miele Limited**

Headquarters and Miele Centre

161 Four Valley Drive
Vaughan, ON L4K 4V8
www.miele.ca

Customer Care Centre

Phone: 1-800-565-6435
customercare@miele.ca

**Germany
Manufacturer**

Miele & Cie. KG
Carl-Miele-Straße 29
33332 Gütersloh

H 2265-1 B, H 2265-1 E, H 2265-1 I