



Operating and Installation Instructions Oven



To prevent accidents and machine damage, read these instructions **before** installation or use.

Contents

IMPORTANT SAFETY INSTRUCTIONS	5
Guide to the oven	15
Oven controls	16
Mode selector	17
Display	17
Symbols in the display	17
Rotary selector	17
Sensor buttons	18
Features	20
Model numbers	20
Data plate	20
Items included	20
Standard and optional accessories.....	20
Shelf runners	20
Universal tray and Wire oven rack.....	21
FlexiClips with wire rack HFCBBR 30-2	21
Oven controls	24
Oven safety features	24
System lock  for the oven	24
Cooling fan	24
Vented oven door	24
Safety Door Lock for Self Clean	24
PerfectClean surfaces	25
Self Clean ready accessories	25
Before using for the first time	26
Before using for the first time.....	26
Setting the time of day for the first time	26
Heating the oven	27
Settings	28
Changing the time of day	28
Changing factory default settings	29
System lock 	32
Timer	34
Setting the timer	34
At the end of the timer.....	35
Guide to the modes	36

Operating the oven	38
Energy saving tips	38
Quick Guide.....	39
Cooling fan	39
Changing the temperature.....	40
Temperature indicator.....	40
Turning a cooking program On / Off automatically	41
Setting the duration.....	41
Setting a cooking duration and a finish time.....	42
At the end of the cooking duration.....	43
Changing the cooking duration	43
Deleting a cooking duration	43
Deleting a finish time	43
Bake	44
Roast	46
Slow Roasting	47
Broil	49
Defrost	52
Canning	53
Dehydrate	54
Frozen food	55
Gentle Bake	56
Cleaning and care	57
Unsuitable cleaning agents	57
Tips.....	58
Normal soiling.....	58
Stubborn soiling	59
Cleaning the oven interior with Self Clean 	60
Preparing for the Self Clean program.....	60
Starting the Self Clean program	61
At the end of the Self Clean program.....	62
The Self Clean program is canceled	63
Door removal.....	64
Reinstalling the door	65
Removing the shelf runners.....	66

Contents

Frequently asked questions	67
Technical Service	72
Caring for the environment	73
Electrical connection	74
Installation diagrams	75
Appliance and cut-out dimensions	75
Undercounter installation	75
Installation into a tall cabinet.....	76
Installing the oven	77

IMPORTANT SAFETY INSTRUCTIONS

When using the appliance, follow basic safety precautions, including the following:

Read all instructions before installation and use of the oven to prevent accidents and machine damage.

This appliance complies with current safety requirements. Improper use of the appliance can lead to personal injury and material damage.

Read all instructions before installing or using the oven for the first time. Only use the appliance for its intended purpose.

Keep these operating instructions in a safe place and pass them on to any future user.

Appropriate use

- ▶ This appliance is intended for residential use only. Use only as described in these operating instructions.
- ▶ This appliance is not intended for outdoor use.
- ▶ Only use this oven for residential cooking, and the purposes described in this manual. Other uses are not permitted and can be dangerous.
- ▶ Risk of Fire! Do not use this oven to store or dry flammable materials.
- ▶ Persons who lack physical, sensory or mental abilities, or experience with the appliance should not use it without supervision or instruction by a responsible person.

IMPORTANT SAFETY INSTRUCTIONS

Safety with children

▶ Children should not be left alone or unattended in an area where an oven is in use. Never allow children to operate, sit or stand on any part of the oven. **Caution:** Do not store items of interest to children in cabinets above an oven. Children climbing on the oven to reach these items could be injured.

▶ Burn Hazard - Do not allow children to use the oven. Failure to do so can result in severe burns or serious injury.

▶ Danger of suffocation! Ensure that any plastic wrappings, bags, etc. are disposed of safely and kept out of the reach of children.

▶ Danger of burns. The oven gets hot at the oven door glass, the vapor vent, the handle and the operating controls. Do not allow children to touch or play in, on or near the oven.

▶ Danger of burns.

Children's skin is more sensitive to high temperatures than that of adults. The oven becomes hotter during self-cleaning than it does in normal use. Do not let children touch the oven while the Self Clean program is running.

IMPORTANT SAFETY INSTRUCTIONS

Technical safety

- ▶ This appliance must be installed and connected in compliance with the installation instructions.
- ▶ Unauthorized installation, maintenance, and repairs can cause considerable danger for the user. Installation, maintenance, and repairs must only be carried out by a Miele authorized technician.
- ▶ Maintenance by the user: Never repair or replace any part of the appliance unless the instructions specifically recommend doing so. Service work should only be performed by a qualified technician.
- ▶ Before installing the oven, check for externally visible damage. Do not operate a damaged appliance.
- ▶ Reliable and safe operation of the oven can only be guaranteed if it is connected to the power supply.
- ▶ To guarantee the electrical safety of this appliance, continuity must exist between the appliance and an effective grounding system. This appliance must be grounded. Connect only to properly grounded outlet. See “Electrical connection - GROUNDING INSTRUCTIONS”. It is imperative that this basic safety requirement be met. If there is any doubt, have the electrical system of the house checked by a qualified electrician.
- ▶ Proper installation: Make sure that your appliance has been installed correctly and that it has been grounded by a qualified technician.
- ▶ Before installation, make sure that the voltage and frequency listed on the data plate correspond with the household electrical supply. This data must correspond to prevent injury and machine damage. Consult a qualified electrician if in doubt.

IMPORTANT SAFETY INSTRUCTIONS

- ▶ Before installation or service, disconnect the power supply to the work area by
 - removing the fuse,
 - “tripping” the circuit breaker, or
 - unplugging the unit. Pull the plug not the cord.
- ▶ Extension cords do not guarantee the required safety of the appliance (e.g. danger of overheating). Do not use an extension cord to connect this appliance to electricity.
- ▶ The oven is not to be operated until it has been properly installed within cabinetry.
- ▶ **Danger of electric shock!**
Under no circumstances open the outer casing of the appliance.
- ▶ This appliance must not be used in a non-stationary location (e.g. on a ship).
- ▶ Do not repair or replace any part of the appliance unless specifically recommended in the operating instructions. All other servicing should be referred to a qualified technician.
- ▶ Defective components should be replaced by Miele original parts only. Only with these parts can safety of the appliance be assured as intended by the manufacturer.
- ▶ In order for the oven to function correctly, it requires an adequate supply of cool air. Ensure that the air flow is not impaired (e.g. insulation in the cabinetry). Also be sure that the cool air supply is not heated by other sources nearby.
- ▶ If the oven is installed behind a cabinet door, do not close the door while the oven is in operation. Heat and moisture can build up behind the closed door and cause damage to the oven, cabinetry and flooring. Do not close the door until the oven has completely cooled down.

IMPORTANT SAFETY INSTRUCTIONS

Correct use

 The oven becomes very hot while in use. Use caution to ensure that you are not burned on the heating elements or interior surfaces of the oven. Use pot holders when placing food in the oven, adjusting the racks, etc. in a hot oven.

- ▶ Caution: Heating elements may be hot even though they are not glowing. Interior surfaces of an oven become hot enough to cause burns. External parts of the oven such as the door glass, vents, and the control panel can become hot. During and after use, do not touch, or let clothing or other flammable materials come into contact with heating elements or interior surfaces of the oven until they have had sufficient time to cool.
- ▶ Do not let food sit in the oven for an extended period of time before or after cooking. Doing so can result in food poisoning or sickness.
- ▶ It is important that the heat is evenly distributed throughout the food being cooked. This can be achieved by stirring and/or turning the food.
- ▶ Use only dry, heat-resistant potholders. Moist or damp potholders used on hot surfaces may result in steam burns. Do not let potholders come in contact with oil or grease. Do not substitute dish towels or other bulky items for potholders. Do not let potholders touch hot heating elements.
- ▶ Loose fitting or hanging garments present a fire hazard. Wear proper apparel while operating the appliance.
- ▶ Do not heat unopened containers of food in the oven, pressure may cause the containers to burst and result in injury.
- ▶ Never pour cold water onto hot surfaces in a hot oven. The steam created could cause serious burns or scalding and the sudden change in temperature can damage the enamel in the oven.

IMPORTANT SAFETY INSTRUCTIONS

- ▶ To prevent burns, always place oven racks at their desired height while the oven is cool. If the rack must be moved while the oven is hot, do not let pot holders touch hot heating elements.
- ▶ Open the door carefully to allow hot air or steam to escape before placing or removing food.
- ▶ To prevent burns, allow the heating elements to cool before cleaning by hand.
- ▶ Do not leave the oven door open unnecessarily as someone may trip over it or be injured by it.
- ▶ Never leave the appliance unattended when cooking with oil or fat. They can ignite if overheated. Do not use water on grease fires. Turn off the oven immediately and suffocate the flames by keeping the oven door closed.
- ▶ Never store flammable liquids and materials in, above or under an oven, or near cooking surfaces.
- ▶ Do not use the oven to heat the room. The high temperatures radiated could cause objects near the oven to catch fire.

WARNING

NEVER use this appliance as a space heater to heat or warm the room. Doing so may result in carbon monoxide poisoning and overheating of the oven.



WARNING

NEVER use this appliance as storage space. Doing so may result in carbon monoxide poisoning and overheating of the oven.

IMPORTANT SAFETY INSTRUCTIONS

WARNING

NEVER cover any slots, holes or passages in the oven bottom or cover an entire rack with materials such as aluminum foil. Doing so blocks air flow through the oven and may cause carbon monoxide poisoning. Aluminum foil linings may also trap heat, causing a fire hazard.

- ▶ Broiling food for an excessively long time can cause it to dry out and may result in the food catching fire. Do not exceed recommended broiling times.
- ▶ Some foods dry out very quickly and can be ignited by high broiling temperatures. Do not use broiling modes for crisping rolls or bread, or to dry flowers or herbs. Instead use the Convection Bake  or Surround  modes.
- ▶ Use caution when using alcohol in your recipes. Alcohol evaporates at high temperatures but may, in rare circumstances, combust on the hot heating elements.
- ▶ Plastic containers, which are not heat-resistant, melt and may ignite at high temperatures and can damage the oven. Use only plastic containers that are indicated by the manufacturer as being suitable for use in ovens.
- ▶ When residual heat is used to keep food warm, the high level of humidity and condensation can cause damage in the oven. The control panel, countertop or cabinetry may also be damaged. Do not switch the oven off completely while food is inside it, but select the lowest possible temperature for the oven mode you are using. This will ensure the fan will automatically continue to run.
- ▶ It is recommended to cover all cooked food that is left in the oven to be kept warm. This will prevent moisture from condensing on the interior of the oven.

IMPORTANT SAFETY INSTRUCTIONS

- ▶ To avoid damage, do not place aluminum foil, pots, pans or baking sheets directly on the oven floor. This can cause a build up of heat that will damage the oven floor.
- ▶ Do not slide pots or pans on the oven floor. This could scratch and damage the surface.
- ▶ The door can support a maximum weight of 33 lbs (15 kg). Do not sit on or lean against an open door, and do not place heavy objects on it. Also make sure that nothing can get trapped between the door and the oven cavity. The oven could get damaged.
- ▶ This oven must only be used for cooking food. Fumes, vapors or heat given off by glues, plastics or flammable liquids and materials could be hazardous. Do not use it as a dryer, kiln, dehumidifier, etc.
- ▶ Do not obstruct the flow of combustion and ventilation air.
- ▶ Do not let metal objects (aluminum foil, pans) come in contact with the heating element.
- ▶ Make certain that the power cords of small appliances do not come in contact with or get caught in the oven door.
- ▶ When baking frozen pizzas or pies, place them on the wire rack lined with parchment paper. Do not use the baking tray or the roasting pan for frozen foods with a large surface area. The tray or pan could become warped and difficult to remove from the oven when hot. Frozen foods like french fries, chicken nuggets, etc. can be baked on the baking tray.

IMPORTANT SAFETY INSTRUCTIONS

Cleaning and maintenance

- ▶ Do not use a steam cleaner to clean this oven. Steam could penetrate electrical components and cause a short circuit.
- ▶ Only clean parts listed in these Operating and Installation Instructions.
- ▶ Scratches on the door glass can cause the glass to break. Do not use abrasive cleaners, hard sponges, brushes or sharp metal tools to clean the door glass.
- ▶ The shelf runners can be removed for cleaning purposes (see “Cleaning and care”). Ensure they are correctly fitted after cleaning and never operate the oven without the shelf runners inserted.
- ▶ There is a seal around the oven interior which seals the inside of the door. Take care not to rub, damage or move the gasket. Do not clean the door gasket - the door gasket is essential for a good seal.
- ▶ Do not use a protective coating to line the oven and do not use commercial oven cleaner unless certified for use in a self-cleaning oven.
- ▶ Debris should be removed before running the Self Clean program. If not removed this debris can smoke causing the self-cleaning program to turn itself off.

IMPORTANT SAFETY INSTRUCTIONS

Accessories

- ▶ Use only genuine original Miele parts. If parts or accessories from other manufacturers are used, the warranty will become void.
- ▶ The high temperatures used during self-cleaning will damage accessories that are not designed for cleaning in the Self Clean program. Please remove these accessories from the oven before starting the Self Clean program. This also applies to accessories purchased separately (see “Cleaning and care”).

SAVE THESE INSTRUCTIONS AND REVIEW THEM PERIODICALLY

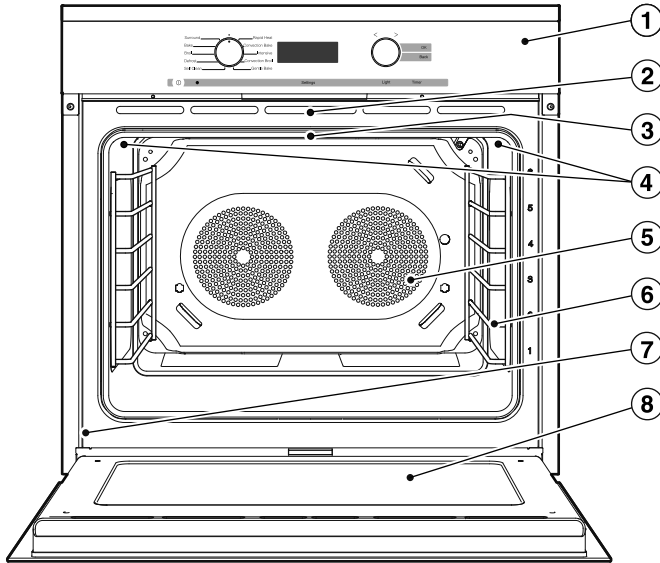

- ① Control panel
- ② Door with contact switch* and lock for Self Clean program
- ③ Browning/Broiling element
- ④ Oven interior lighting
- ⑤ Twin Power convection fans with heating element
- ⑥ Shelf runners with 6 levels
- ⑦ Data plate
- ⑧ Clean Glass door

* This switch ensures that the heating elements and the convection fans turn off when the door is opened during use.

Oven controls

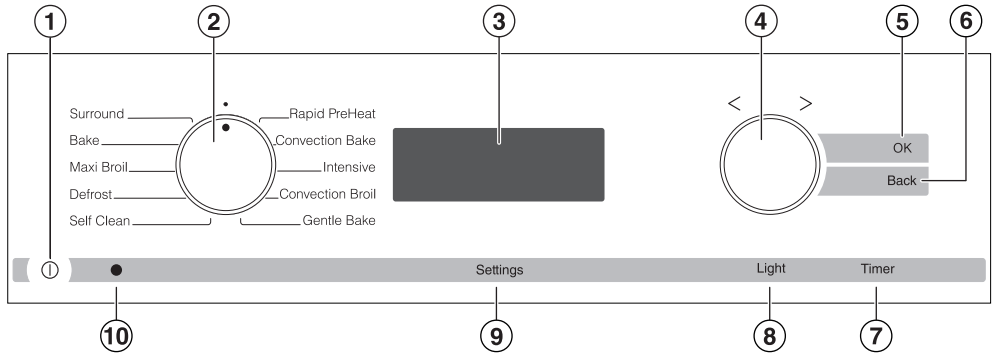





- ① On / Off button ①
Turns the oven on and off
- ② Mode selector
To select oven modes
- ③ Display
Displays the time of day and settings
- ④ Rotary selector < >
To select values
- ⑤ OK sensor button
Confirms settings and instructions
- ⑥ “Back” sensor button
To go back one step at a time
- ⑦ “Timer” sensor button
To set the timer
- ⑧ “Light” sensor button
To turn the oven cavity lighting on and off
- ⑨ “Settings” sensor button
To access settings
- ⑩ Optical interface
(for service technician use only)

Mode selector

To select an oven mode.

It can be turned clockwise or counter-clockwise.

Oven modes

-  Surround
-  Bake
-  Maxi Broil
-  Defrost
-  Self Clean
-  Rapid PreHeat
-  Convection Bake
-  Intensive
-  Convection Broil
-  Gentle Bake









Display

The display shows the time of day or your settings.



Symbols in the display

Depending on the position of the mode selector ○ and/or which button is pressed, the following symbols will appear:

Symbol / Function		○
	Timer	Any
	Temperature indicator	Oven mode
	Duration	
	Finish time	
	Temperature	
	Settings <i>P</i>	•
	Time of day	
	System lock	

A function can only be set or changed if the mode selector is in the correct position.

Rotary selector

Use the rotary selector < > to enter temperatures and durations.

Turning it clockwise will increase the values, and turning it counter-clockwise will decrease them.

It can also be used to highlight a mode by moving the ▲ in the display.

It can be turned clockwise or counter-clockwise.







Oven controls

Sensor buttons

The sensor buttons react to touch. Each touch is confirmed with an audible tone. The tone can be turned on or off by selecting the status *S 0* in the settings *P 3* (see “Settings”).

Sensor button	Function	Notes
OK	For accessing functions and saving settings	When functions are marked with a ▲ they can be accessed by selecting OK. As long as the triangle ▲ is flashing you can change the selected function. Press OK to save the change.
Back	To go back a step	
Timer	For setting the kitchen timer	If the time of day is visible, you can enter a timer duration at any time, e.g. when boiling eggs on the cooktop. If the display is turned off, the “Timer” button will not react until the oven is turned on.

Oven controls

Sensor button	Function	Notes
Light	For turning the oven interior lighting on and off	<p>If the time of day display is turned on, the oven interior lighting can be turned on and off by touching the “Light” sensor button, for example when cleaning the oven.</p> <p>If the time of day display is turned off, the “Light” sensor button will not react until the oven is turned on.</p> <p>The oven interior lighting turns off after 15 seconds during cooking or remains constantly turned on, depending on the setting selected.</p>
Settings	To access Functions	<p>If the time of day is visible in the display and the mode selector is in the • position, and selecting the sensor button “Settings” the symbols for Settings , Time of day , and System Lock  will appear.</p> <p>If the display is turned off, the “Settings” button will not react until the oven is turned on.</p> <p>When cooking you can set the button after selecting the temperature , cooking time  and finish time .</p>

Features

Model numbers

A list of the ovens described in these operating instructions can be found on the back page.

Data plate

The data plate located on the front frame of the oven is visible when the door is open.

Printed on the data plate are the model number, serial number and the connection data (voltage/frequency/maximum rated load) of the oven.

Have this information available when contacting Miele Technical Service.

Items included

The following items are included with this appliance:

- the operating and installation instructions for using the oven,
- screws for securing your appliance into the cabinetry, and
- various accessories.

Standard and optional accessories

Accessories vary depending on model. **All ovens are supplied with shelf runners, a universal tray and a wire oven rack.** Depending on the model, your oven may also come with the additional accessories listed.

All accessories and cleaning and care products in these instructions are designed to be used with Miele ovens.

These can be ordered from the Miele web store, Miele Technical Service, or from your Miele dealer.

When ordering, please have ready the model number of your oven and of the desired accessories.

Shelf runners

The shelf runners are located on the right and left-hand sides of the oven with the levels for inserting accessories.

The shelf level numbers are indicated on the front of the oven frame.

Each level consists of a strut on which you can place the wire oven rack, for example.

The runners can be removed. See “Cleaning and Care”.

Universal tray and Wire oven rack

Universal tray HUBB 30-1

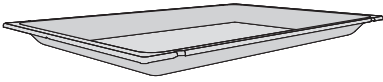

Wire oven rack HBBR 30-2

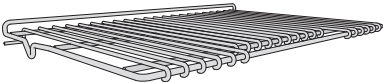

Non-tip safety notches are located on the shorter sides of these accessories. These prevent the trays being pulled completely out of the side runners when you only wish to pull them out partially.

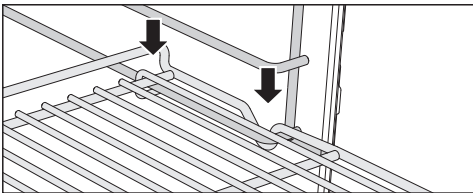

Always place the wire oven rack on the runner with the notch facing down.

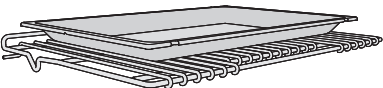

When using the universal tray, place it directly on the wire oven rack.

FlexiClips with wire rack HFCBRR 30-2

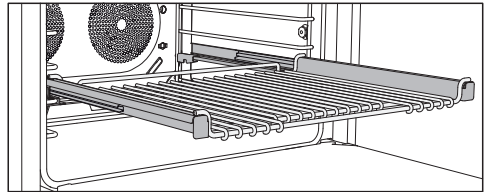

The FlexiClips with wire rack can be mounted on any shelf level and pulled completely out of the oven. This allows you to see the food easily.

The FlexiClips with wire rack is pushed in and then locked onto a level.

The rack can hold a maximum of 33 lbs (15 kg).

Installing and removing the FlexiClips with wire rack

 **Danger of burns!** Make sure the heating elements are turned off and that the oven cavity is cool.

Do not pull the FlexiClips apart during installation or removal.

- Hold the FlexiClips with wire rack with both hands and position it in front of the desired level.

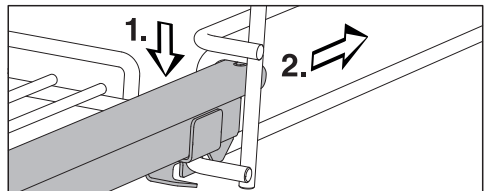

- Insert the FlexiClips with wire rack onto the level (1.) and slide it along the struts of the level (2.) until it clicks into place.

Features

If the FlexiClips with wire rack jams when sliding it onto the level, pull it out using some force and reinsert.

To removing the FlexiClips with wire rack:

- Push the FlexiClips with wire rack in all the way.

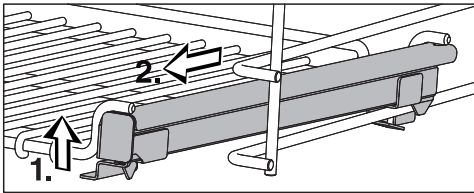

- Using both hands lift the front of the FlexiClips with wire rack on both sides (1.) and pull it out of the level (2.).

Using the universal tray

- When using the universal tray, place it directly on the FlexiClips with wire rack.

Perforated Gourmet baking tray HBBL 71

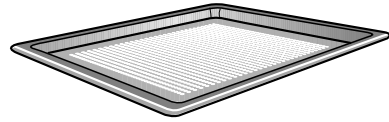

The perforated Gourmet baking tray has been specially developed for the preparation of baked goods made from fresh yeast and quark doughs. The tiny perforations assist in browning the underside of baked goods. The tray can also be used for dehydrating or drying food.

The enameled surface has been treated with PerfectClean.

The **round perforated baking tray HBFP 27-1** can be used for the same things.

The perforated baking tray can be placed on the rack.

Grilling and Roasting insert HGBB 30-1

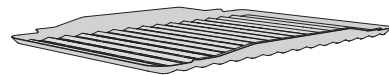

The grilling and roasting insert is placed in the universal tray.

The drippings from the meat or poultry are collected under the insert reducing spattering in the oven. The drippings can then be used for gravy and sauces.

The surface has been treated with PerfectClean enamel for easy cleaning.

Round baking form HBF 27-1



This circular form is suitable for cooking fresh or frozen pizzas, flat cakes, tarts and baked goods.

The surface has been treated with PerfectClean enamel.

Gourmet Baking Stone HBS 60

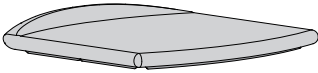

The baking stone is ideal for baking dishes with a crisp bottom such as pizza and bread.

The baking stone is made from a heat retaining stone and is glazed. Place the stone directly on the wire rack.

A wooden peel is supplied with it for placing food on and off the stone.

HUB Gourmet casserole dishes HBD casserole dish lids

Miele Gourmet casserole dishes can be placed directly on the wire oven rack. The surface of the casserole dishes has a non-stick coating.

Gourmet casserole dishes are available in different depths. The width and the height are the same.

Suitable lids are available separately. Please quote the model number when ordering.

Depth:
8 1/2" (22 cm)

HUB 62-22 *

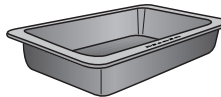

HBD 60-22

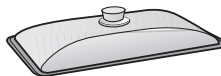

Depth:
13 3/4" (35 cm)

HUB 62-35 *

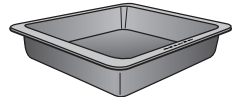

HBD 60-35

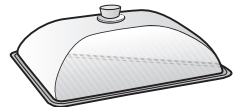

* Suitable for use on induction cooktops

Opener

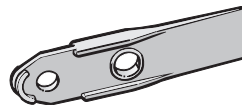

The opener allows you to open the cover of the oven light.

Miele Oven Cleaner

Miele oven cleaner is suitable for removing stubborn soiling. It is not necessary to preheat the oven before use.

Features

Oven controls

The oven controls enable you to use the various cooking functions to bake, roast and broil.

It also allows you to access:

- the time of day display
- a kitchen timer
- a timer to automatically turn cooking programs on and off
- settings that can be customized

Oven safety features

System lock for the oven

The system lock prevents the oven from being used unintentionally (see “System lock 

The system lock will remain activated even after a power failure.

Cooling fan

The cooling fan comes on automatically when a cooking program is started. The cooling fan mixes hot air from the oven cavity with cool room air before venting it out into the kitchen through vents located between the appliance door and the control panel.

The cooling fan will continue to run for a while after a program is complete to prevent moisture from building up in the oven, on the control panel or surrounding cabinetry.

When the temperature in the oven has fallen sufficiently, the cooling fan will turn off automatically.

Vented oven door

The oven door is made of glass panes that have a heat-reflective coating on part of their surface.

During operation, air is also circulated through the door to keep the outer panel cool.

The door can be removed and disassembled for cleaning purposes (see “Cleaning and care”).

Safety Door Lock for Self Clean

For safety reasons, the door is locked as soon as the Self Clean program is started. After the self-cleaning program has finished, the door will remain locked until the temperature in the oven has fallen below 535°F (280°C).

PerfectClean surfaces

The revolutionary PerfectClean finish is a smooth, non-stick surface that is exceptionally easy to clean.

Food and grime from baking or roasting are easily removed.

Do not use ceramic knives, as these will scratch the PerfectClean surface.

Follow the instructions in the “Cleaning and Care” section of this manual so the anti-stick and easy cleaning properties are retained.

The following have all been treated with PerfectClean:

- Universal tray
- Grilling and Roasting insert
- Perforated baking tray
- Round baking form

Self Clean ready accessories

The following accessories can be left in the oven during the Self Clean program.

- Shelf runners
- Wire oven rack

See “Cleaning and care” for more information.

Before using for the first time

Before using for the first time

 The oven must not be operated until it has been properly installed within cabinetry.

The time of day can only be changed when the mode selector is in the ● position.

- Set the time of day.

Setting the time of day for the first time

The time of day is shown in 12 hour clock format.

After connection the oven to the electrical supply 12:00 will appear in the display and a ▲ will flash under :



- Use the rotary selector to enter the time of day.
- Confirm with OK.

The time of day is now saved.

To change the time of day to a 24-hour format setting, choose 24h in the Settings P 4 menu (see “Settings”).

During a power outage, the time of day will be saved for approx. 200 hours. If the power returns within this period of time the current time of day is displayed again. If the power is out for an extended period of time the time of day will need to be reset.

The time of day is turned off by default (see “Settings - P 1”).

The display will appear dark when the oven is turned off. The time of day continues to run unseen in the background.

Setting the voltage (electrical version)

 The voltage set must match that of the house as to not damage the oven.

Confirm the voltage before setting. In in doubt contact a qualified technician.

- Use the rotary selector to select the voltage for your power supply.
- Confirm with OK.

The oven is now ready for use.

Before using for the first time

Heating the oven

New ovens may have a slight odor during their first use. Heating up the oven for at least one hour with nothing in it will eliminate the odor.

Ensure that the kitchen is well ventilated while the appliance is being heated up for the first time. Close doors to other rooms to prevent the smell spreading throughout the house.

- Remove any protective wrapping and sticky labels from the oven.
- Take all accessories out of the oven and clean them (see “Cleaning and care”).
- Before heating the oven up, wipe the interior with a damp cloth to remove any dust or bits of packaging that may have accumulated in the oven cavity during storage and unpacking.
- Turn on the oven.
- Select Convection Bake .

The default temperature appears in the display and a ▲ flashes under :



- Use the rotary selector < > to set the maximum temperature possible.
- Confirm with OK.

The oven heating will turn on.

- Heat up the oven for at least an hour.

After at least an hour:

- Turn the mode selector to ●.

After heating up for the first time

 Danger of burns! Allow the oven to cool before cleaning.

- Turn on the oven.
- Select Light to turn on the oven light.
- Take all accessories out of the oven and clean them by hand (see “Cleaning and care”).
- Clean the oven interior with warm water and liquid dish soap, applied with a soft sponge or cloth.
- Dry all surfaces with a soft cloth.
- Turn the lighting and the oven off.

Leave the oven door open until the oven interior is completely dry.

Settings

Changing the time of day

The time of day can only be changed when the oven is turned on and the mode selector is at the • position.

- Turn on the oven.
- Select “Settings”.
- Use the rotary selector to move the ▲ until it appears under ⌚.
- Confirm with OK.

The ▲ symbol will flash under ⌚.

- Use the rotary selector to enter the time of day.
- Confirm with OK.

The time of day is now saved.

During a power failure, the time of day will be saved for approx. 200 hours. When the power returns within this period of time the current time is displayed again.

After an extended power failure, the time of day will need to be reset.

Changing factory default settings

The appliance is supplied with a number of default settings (see the “Settings overview” chart).

A setting can be changed by altering its status.

The settings can only be changed when the oven is turned on and the mode selector is at the **•** position.

- Select “Settings”.
- If necessary, use the rotary selector to move the **▲** symbol until it appears under Settings.



- Confirm with OK.

P appears:



- If you would like to change another setting, use the rotary selector to select the appropriate number.
- Confirm with OK.



The setting is selected and the current status appears, e.g. *5 |*.

To change the status:

- Use the rotary selector to select the desired status.
- Confirm with OK.

The status is saved and the setting appears again.

- If you would like to change additional settings, repeat the process.
- If you do not wish to change the setting shown and would like to move to another setting select Back.
- If you have completed changing settings, select Settings.

The settings will remain in memory even in the event of a power failure.

Settings

Settings overview

Setting	Status	
<i>P 1</i> Time of day display	<i>S 0*</i>	The time of day display is turned off . The display is dark when the oven is turned off. The time of day continues to run unseen in the background. If you have selected status <i>S 0</i> , the oven must be turned on before it can be used. This also applies for the Timer and Light. The oven also switches off automatically if no settings are selected within a certain period of time (approx. 30 minutes).
	<i>S 1</i>	The time of day display is turned on and is visible in the display.
<i>P 2</i> Buzzer volume	<i>S 0</i>	The buzzer is Off .
	<i>S 1</i> to <i>S 21*</i>	The buzzer is On . The volume can be changed. The corresponding buzzer will be heard when a status is selected.
<i>P 3</i> Keypad tone	<i>S 0</i>	The keypad tone is turned off .
	<i>S 1*</i>	The keypad tone is turned on .
<i>P 4</i> Clock format	<i>24h</i>	The time of day is shown in a 24-hour format .
	<i>12h *</i>	The time of day is shown in the 12-hour format . If you change the clock after 1 pm (13:00) from a 12-hour clock to a 24-hour clock, you will need to update the hours for the time of day accordingly.
<i>P 5</i> Temperature unit	<i>°C</i>	The temperature is displayed in Celsius .
	<i>°F *</i>	The temperature is displayed in Fahrenheit .

* Factory default

Setting	Status
<i>P 6</i> Display brightness	<i>5 1-5 7, 5 4*</i> Different levels of brightness can be selected for the display. <i>5 1</i> : Minimum brightness <i>5 7</i> : Maximum brightness
<i>P 7</i> Lighting	<i>5 0*</i> The oven interior lighting is on for 15 seconds and then turns off automatically. <i>5 1</i> The oven interior lighting is permanently turned on .
<i>P 8</i> Calibrate temperature	<i>0*</i> <i>-3 to 3</i> The temperature can be modified so that it is slightly higher or lower than shown. The higher the level, the higher the cooking temperature.
<i>P 9</i> Electrical Version	<i>208U</i> Connection to a 208 V, 60 Hz power supply. <i>220U</i> Connection to a 220 V, 60 Hz power supply. <i>230U</i> Connection to a 230 V, 50 Hz power supply. <i>240U</i> Connection to a 240 V, 60 Hz power supply.
<i>P 10</i> Demo Mode	<i>5 0*</i> Select <i>5 0</i> and press OK for approx. 4 seconds. When - - - appears in the display the demo mode is deactivated . <i>5 1</i> Select <i>5 1</i> and press OK for approx. 4 seconds. When <i>DES_</i> appears in the display the demo mode is active . The oven can be operated, but the oven heating does not work. For personal use you do not need this setting.

* Factory default

System lock

The system lock  prevents the oven from being used unintentionally.

The system lock is set off by default. This can be changed by setting the status 5:

- 5 0 = Off
- 5 1 = On

The status of the system lock can only be altered when the oven is turned on and the mode selector is at ●.

To activate the system lock

- Select “Settings”.
- Use the rotary selector to move the ▲ until it appears under .

The currently set Status 5 0 appears:



- Confirm with OK.
- Use the rotary selector to set Status 5 1.



- Confirm with OK.
- Select “Settings”.

The current time of day appears.

- Turn the oven off.



The system lock is On.

When the appliance is turned on again, the  symbol will appear in the display to remind you that the system lock has been activated.

The system lock will remain activated even after a power failure.

Deactivating the system lock for a cooking process

- Turn on the oven.



The  and  symbols will appear along with the current time of day:



- Press and hold OK until  goes out.

The oven can now be used.

Deactivating the system lock

- Turn on the oven.
- Press and hold OK until  goes out.
- Select “Settings”.
- Use the rotary selector to move the  until it appears under .
- Confirm with OK.

The currently set status *S l* appears.

- Use the rotary selector to set Status *S 0*.
- Confirm with OK.
- Select “Settings”.

The system lock is Off.

The  symbol disappears.

Timer

The timer can be used to time any activity in the kitchen, e.g. boiling eggs.

The timer can also be used at the same time as a cooking program if a start and finish time have been set, e.g. a reminder to stir the dish or add seasoning.

A maximum time of 99 minutes and 55 seconds can be set for the timer.

Setting the timer

Example: Boiling eggs and setting the timer for 6 minutes and 20 seconds.

If you have selected the “P1 - 5 0” setting for the time of day display, you will need to turn the oven on before you can set a kitchen timer time.

- Select “Timer”.

00:00 will appear in the display with ▲ flashing under ⏰:

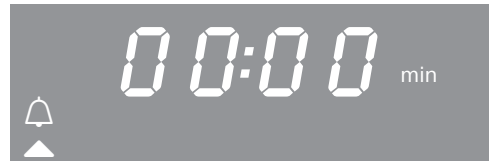

- Use the rotary selector to set the kitchen timer time desired.



- Confirm with OK.

The timer settings are saved and will count down in seconds:



The ⏰ symbol indicates that the timer has been set.

At the end of the timer

- 🔔 flashes.
- The time starts counting upwards.
- A buzzer will sound if turned on (see “Settings - P 2”).
- Select “Timer”.

The buzzer will turn off and the symbols in the display will go out.

Resetting the timer

- Select “Timer”.
- The time previously set appears
- Use the rotary selector to change the kitchen timer time.
 - Confirm with OK.

The changed time is saved and will count down in seconds.

Canceling the timer





- Select “Timer”.
- Use the rotary selector to reduce the kitchen timer time to *00:00*.
- Confirm with OK.

The timer has been canceled.







Guide to the modes

The oven has a wide range of modes for preparing a variety of foods.

Due to country-specific preferences for preparation of food, default temperatures and temperature ranges in °F and °C do not correspond. The temperature values have been defined as given in the chart.

Mode	Default temperature	Temperature range
Surround  This premium baking mode uses heat from the upper and lower elements to create perfect results on all baking recipes.	350 °F (180 °C)	75–525 °F (30–280 °C)
Bake  This mode uses traditional baking techniques to perfect pies and biscuits.	375 °F (190 °C)	200–525 °F (100–280 °C)
Maxi Broil  For broiling meats e.g. steak, chops, kebabs, etc. The entire Browning / Broiling element will glow red to produce the required heat.	500 °F (240 °C)	400–575 °F (200–300 °C)
Defrost  For the gentle defrosting of frozen food.	100 °F (25 °C)	75–150 °F (25–50 °C)
Self Clean During the Self Clean program, any soiling is broken down into ash by the high temperatures.	–	–

Guide to the modes

Mode	Default temperature	Temperature range
Rapid PreHeat  This mode allows the oven to be heated to the desired temperature quickly. Once the desired temperature has been reached the oven mode must be selected.	350 °F (160 °C)	200–475 °F (100–250 °C)
Convection Bake  Use this mode for baking and roasting on several levels at the same time. You can cook at lower temperatures than with the Surround  mode because the fan distributes the heat evenly throughout the cavity for a consistent baking temperature.	350 °F (160 °C)	75–475 °F (30–250 °C)
Intensive  This mode gently circulates heated air from the lower heating element using the fan to create a brick oven environment. Ideal for baking pizza, focaccia, pies and tarts that require a crisp base and moist toppings.	400 °F (170 °C)	125–475 °F (50–250 °C)
Convection Broil  This mode distributes hot air from the Browning/ Broiling element over the food using the fan. This allows for a lower temperature to be used than when using Broil  . Ideal for broiling thicker cuts of meat (e.g. chicken, roulades).	400 °F (200 °C)	200–500 °F (100–260 °C)
Gentle Bake  A combination of different heating elements ensures excellent baked good, gratins and lasagna.	350 °F (190 °C)	200–475 °F (100–250 °C)

Operating the oven

Energy saving tips

- Remove any accessories from the oven that you do not require for cooking.
- Try not to open the door when cooking.
- If a temperature range is given, it is best to select the lower temperature and check the food after the shortest cooking time given.
- The factory default setting “P 1 – 5 0” for the time of day display will consume the least amount of energy.
- With the factory default setting “P 7 – 5 0” the oven interior lighting turns off automatically after 15 seconds. It can be turned on again at any time by touching .
- When cooking with temperatures above 285°F (140°C) and cooking durations longer than 30 minutes, turn the temperature selector down approx. 5 minutes before the end of cooking. The oven heating elements will turn off and the residual heat will finish cooking the food.
- The oven turns off automatically if a button is not pressed to save power. The amount of time before the oven turns off depends on the selected settings, e.g. oven mode, temperature, cooking duration, etc.

Quick Guide

- Turn on the oven.
- Place the food in the oven.
- Using the mode selector select the required oven mode.

The default temperature is displayed:



The oven heating, lighting and cooling fan will turn on.

- Use the rotary selector to change the temperature if necessary.

The current temperature and temperature indicator light  appear after a short time.



You will see the temperature rising in the display. A buzzer will sound when the oven temperature is reached if this option is selected (see “Settings - $\frac{E1}{7B} 2$ ”).

After the cooking process:

- Turn the mode selector to •.
- Take the food out of the oven.
- Turn the oven off.

Cooling fan

After the cooking process the cooling fan will continue to run for a while after a program is complete to prevent moisture from building up in the oven, on the control panel or surrounding cabinetry.

When the temperature in the oven has fallen sufficiently the cooling fan will turn off automatically.

Operating the oven

Changing the temperature

Example: You have selected Convection Bake  and 350°F (175°C) and you can see the temperature rising in this display.



You would like to reduce the set temperature to 310°F (155 °C).

- Use the rotary selector to reduce the temperature.

The ▲ symbol will flash under  and the temperature is altered in 5°F (5°C) increments.



The altered target temperature is saved. The actual temperature is displayed.

Select “Settings” to toggle between displaying the actual temperature and the set temperature.

Temperature indicator

The temperature indicator light  turns on whenever the oven heating is turned on.

Once the set temperature has been reached:



- a buzzer will sound if turned on (see “Settings - P 2”),
- the temperature indicator light  will go out, and
- the oven heating will turn off.

The temperature regulator ensures that the oven heating and temperature indicator light turn back on when the oven temperature falls below the level set.

Rapid PreHeat

With Rapid PreHeat  the preheating phase can be shortened.

Do not use Rapid PreHeat  when baking pizza or delicate mixtures. The tops of these items will brown too quickly.

- Select Rapid PreHeat .
- Select a temperature.
- Set the desired oven mode when the temperature indicator light  goes out for the first time.
- Place the food in the oven.

Turning a cooking program On / Off automatically

You can set a cooking program to turn on or off automatically. First the mode and cooking temperature must be selected.

The maximum duration that can be set for a cooking program is 12 hours.

It is recommended to use the automatic On/Off feature when roasting. Do not delay the start of the program for too long when baking. Cake mixtures and doughs will dry out, and the leavening agents will lose their effectiveness.

Setting the duration

Example: Baking a cake for 1 hour 5 minutes

- Place the food in the oven.
- Select the required oven mode and temperature.

The oven heating, lighting and cooling fan will turn on.

- Select “Settings”.



- If necessary, use the rotary selector to move the ▲ symbol until it appears under ☺.
- Confirm with OK.

00:00 will appear in the display along with a ▲ flashing under ☺.



- Use the rotary selector to select the cooking duration (01:05).
- Confirm with OK.

The cooking duration is saved and then counts down in minutes, with the last minute counting down in seconds.

The ☺ symbol indicates that a cooking duration has been set.

Operating the oven

Setting a cooking duration and a finish time

Example: the current time of day is 11:15; a roast with a cooking duration of 90 minutes needs to be ready at 13:30.

- Place the food in the oven.
- Select the required oven function and the temperature.

The oven heating, lighting and cooling fan will switch on.

First set the cooking duration:

- Select \equiv .
- If necessary, use the rotary selector < > to move the triangle ▲ until it appears under ⌚ .
- Confirm with *OK*.

00:00 will appear in the display with ▲ flashing under ⌚ .

- Use the rotary selector < > to set the cooking duration (01:30).
- Confirm with *OK*.

The cooking duration ⌚ is saved and then counts down in minutes:



Then set the finish time:

- Use the rotary selector < > to move the triangle ▲ until it appears under ⌚ .

-- -- appears:



- Confirm with *OK*.

As soon as you turn the rotary selector < > clockwise, 12:45 will appear (= current time of day + cooking duration = 11:15 + 1:30):



- Use the rotary selector < > to enter the cooking duration finish time (13:30).
- Confirm with *OK*.

The finish time ⌚ is now saved:



The oven heating, lighting and cooling fan will switch off.



As soon as the start time (13:30 - 1:30 = 12:00) has been reached, the oven heating, lighting and cooling fan will switch on.

At the end of the cooking duration

- 0:00 appears in the display.
-  flashes.
- The oven heating and lighting will turn off.
- The cooling fan will continue to run.
- A buzzer will sound if turned on (see “Settings - P 2”).
- Turn the mode selector to •.
- Take the food out of the oven.
- Turn the oven off.

If the dish is not cooked to your liking, you can extend the cooking duration by entering a new duration.

Changing the cooking duration



- Select “Settings”.
- If necessary, use the rotary selector to move the  symbol until it appears under .

The cooking time remaining appears in the display.

- Confirm with OK.
- Use the rotary selector to adjust the cooking duration.
- Confirm with OK.

The changed cooking duration is now saved.

Deleting a cooking duration

- Select “Settings”.
- If necessary, use the rotary selector to move the  symbol until it appears under .

- Confirm with OK.

The  symbol will flash under .

- Use the rotary selector to select the cooking duration (00:00).
- Confirm with OK.

The cooking duration and finish time are deleted.

- Select “Settings”.



The current temperature will appear. The oven heating remains turned on.

To complete the cooking program:

- Turn the mode selector to •.
- Take the food out of the oven.
- Turn the oven off.

If you turn the mode selector to • or turn the oven off, the settings for the cooking duration and the finish time will be deleted.

Deleting a finish time

- Select “Settings”.
- If necessary, use the rotary selector to move the  symbol until it appears under .
- Confirm with OK.

The  symbol will flash under .

- Use the rotary selector to enter the finish time (1:30).
- Confirm with OK.



The finish time is now deleted.

Bake

Eating food which has been cooked correctly is important for good health.



Only bake cakes, pizza, french fries, etc. until they are golden brown. Do not overcook them.

Oven modes

Depending on how you would like the food prepared, you can use Convection Bake , Intensive , or Surround .

Bakeware

The bakeware used depends on the oven mode chosen and how the food is prepared.

- Convection Bake , Intensive : Baking tray, Roasting pan, any heat-resistant baking dishes.
- Surround : Dark metal, enamel or aluminum baking tins with a matte finish, as well as heat-resistant glass, ceramic and coated dishes can be used. Avoid bright, shiny metal tins as they result in uneven or poor browning, and in some cases cakes might not cook properly.

- Always place baking pans on the wire rack. Position rectangular pans with the longer side across the width of the rack. This will allow for optimum heat distribution and even baking results.
- When baking cakes with fruit toppings or deep cakes, place the tin in the universal tray to catch any spills.

Parchment paper / Greasing the pan

All Miele accessories (baking tray, universal tray, perforated baking tray and round baking dish) are treated with PerfectClean finish.

Surfaces treated with PerfectClean finish generally do **not** need to be greased or covered with parchment paper.

Parchment paper is only needed with:

- anything with a high salt content (e.g. pretzels, bread sticks), because sodium can damage the PerfectClean surface;
- meringues or dishes with a high egg-white content, because they are more likely to stick,
- frozen food cooked on the wire oven rack.

Temperature

Select the suggested temperature if possible.



Choosing a baking temperature higher than those recommended may reduce the cooking time, but will lead to uneven browning, and unsatisfactory cooking results.

Baking duration

Check if the food is cooked at the end of the shortest duration quoted. To check if a cake is ready insert a wooden skewer or toothpick into the center, it should come out clean.

Shelf levels

The shelf level that you place the food on for baking depends on the oven mode and the number of trays being used.



- **Convection Bake** 
 - 1 Tray: Level 3
 - 2 Trays: Level 1+3/2+4
 - 3 Trays: Level 1+3+5
- **Intensive Bake** 
 - 1 Tray: Level 2 or 3
- **Surround** 
 - 1 Tray: Level 3

Bake moist cakes and muffins on a maximum of two levels at the same time.

Roast

Always observe the USDA guidelines for food safety.

Oven modes

Depending on how you would like the food prepared, you can use Convection Bake  or Surround .

Cookware



Any heat-resistant cookware can be used:

Wire oven rack, grilling and roasting insert (if available) on the universal tray, roasting pans, heat-resistant glass/earthen/cast iron dishes, roasting bags

Temperature

As a general rule, select a lower temperature.

If higher temperatures are used, the meat will brown on the outside, but will not be properly cooked through.

When cooking with Convection Bake , select a temperature 25°F (20°C) lower than when using Surround .

Shelf levels

In most cases level 3 should be used. With large items, such as a turkey, use level 1 or 2.

Tips

- Resting time: At the end of the program, take the roast out of the oven, cover with aluminum foil and let stand for about 10 minutes. This helps retain the juices when the meat is sliced.
- The larger the cut of meat, the lower the temperature setting should be.
- Use a roast probe for accurate cooking temperatures and best results.

This cooking method is ideal for cooking beef, pork, veal or lamb when a tender result is desired.

First, using a cooktop sear the meat on all sides to seal in the juices.

Then place the meat in a preheated oven. It will be cooked at a low temperature for an extended time allowing the meat to become very tender.

The meat will rest and the juices start to circulate evenly throughout. This gives the meat a very tender and juicy result.

Tips

- Use fresh, lean meat that has been trimmed. Remove the bones before cooking.
- When searing, use a suitable cooking oil or fat that can withstand high temperatures (e.g. clarified butter, vegetable oil).
- Do not cover the meat during cooking.

Cooking will take approx. 2-4 hours, depending on the size and weight of the meat, as well as the desired degree of doneness and browning.

Operation

Place the roasting pan on the wire rack.

Do not use Rapid PreHeat  to preheat the oven.

- Place the rack with the roasting pan on shelf level 3.
- Select Surround  and a temperature of 265°F (130°C).
- Preheat the oven along with the roasting pan and wire rack for approx. 15 minutes.
- While the oven is preheating, sear the meat on all sides on the cooktop.

 **Danger of burns!**
When the oven is hot use pot holders to insert, remove or turn the food, or when adjusting the oven shelves, etc.

- Place the seared meat on the wire oven rack.
- Reduce the temperature to 200°F (100°C).
- Continue cooking until the end of the cooking duration.

You can set the cooking process to finish automatically (see “Operation - Setting the duration”).

Slow Roasting



After cooking:

Because the cooking temperatures are very low:

- The meat can be carved immediately. No resting time is required.
- The cooking result will not be affected if the meat is left in the oven after the program is complete. It can be kept warm until you serve it.
- The meat is at an ideal temperature to be eaten right away. Serve on pre-warmed plates with a hot sauce or gravy to keep warm.

Cooking duration / Core temperatures

Always observe USDA food safety guidelines.

Meat	 [min]	 [°F / °C] **
Beef Tenderloin	80–100	138 / 59
Sirloin		
- rare	50–70	118 / 48
- medium	100–130	135 / 57
- well done	160–190	156 / 69
Pork Tenderloin	80–100	145 / 63
Smoked Pork Chop *	140–170	154 / 68
Filet of Veal	80–100	140 / 60
Veal Loin *	100–130	145 / 63
Saddle of Lamb *	50–80	140 / 60

* boneless

** If desired, use a meat thermometer to monitor the core temperature.



Danger of burns!

Broil with the oven door closed. If you broil with the door open the hot air will escape from the oven before it has been cooled by the cooling fan.

The controls will get hot.

Oven modes

Maxi Broil

For broiling thin cuts of meat and browning.

The entire Browning / Broiling element will get hot and glow red.

Convection Broil

For broiling thicker items, e.g. poultry or London broil.

The Browning/Broiling element and the fan switch on in alternating phases.

Cookware

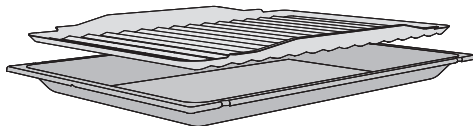

Use the universal tray with the grilling and roasting insert (if available), and place the tray in the oven. The insert prevents any collected meat juices from burning, allowing them to be used for gravy and sauces.

Temperature

As a general rule, select the default temperature.

If higher temperatures are used, the meat will brown on the outside, but will not be properly cooked through.

Preheating

Always preheat the oven for about 5 minutes with the door closed before Broiling.

Broil

Shelf levels

Select the shelf level according to the thickness of the food.

- Thin cuts: Shelf level 4 or 5
- Thick cuts: Shelf level 2 or 3

Broiling time

Flat pieces of fish and meat usually take 6–8 minutes per side.

When broiling thicker pieces, each side will take a bit longer. Make sure that the pieces have roughly the same thickness so that their broiling times do not vary too greatly.

Testing doneness

Always observe USDA food safety guidelines.

Tip: If the surface of a thicker cut of meat is browned but the center is still raw, move the food to a lower level or reduce the temperature and continue cooking. This will stop the surface from becoming too dark.

Preparing food for broiling

Rinse the meat under cold water and pat dry. Do not season the meat with salt before broiling, this will draw out the juices.

Brush the meat with oil, if necessary. Do not use other types of fat as they can easily burn and cause smoke.

Clean fish as usual. To enhance the flavor, salt or lemon can be added.

Broil

- Place the grilling and roasting insert (if available) in the universal tray.
- Place the food on top.
- Select the required oven mode and temperature.
- Preheat the Browning/Broiling element for approx. 5 minutes with the door closed.



Danger of burns!

When the oven is hot use pot holders to insert, remove or turn the food, or when adjusting the oven shelves, etc.

- Place the food on the appropriate shelf level (see the “Broiling chart”).
- Close the door.
- Turn the food halfway through cooking.

Defrost

To gently defrost food use the Defrost  mode.

When this mode is selected, the fan turns on and circulates the air around the oven cavity.

 Risk of salmonella poisoning!
Be sure to strictly observe proper hygiene rules when defrosting poultry.
Do not use the liquid from the defrosted poultry.

Tips

- Remove the packaging and place the frozen food on the universal tray or in a suitable bowl or dish.
- When defrosting poultry, place it on the wire oven rack and position the rack on the universal tray so that the poultry does not sit in the defrosting liquid.

Always observe USDA food safety guidelines.

Canning containers



Danger of injury!

Do not use the appliance to heat up or can food in sealed jars or containers. Pressure will build up inside them and they can explode causing damage to the appliance, as well as the risk of injury and scalding.

Only use jars designed for canning:

- Canning jars
- Jars with twist-off lids

Canning fruit and vegetables

We recommend using the Convection Bake  mode.

The instructions below are for 6 one-liter glass jars.

- Slide the universal tray onto shelf level 3. Place the jars on the tray.
- Select the Convection Bake  mode and a temperature of 300-340°F (150-170 °C).
- Wait until bubbles rise evenly in the jars.

Then reduce the temperature to avoid a boil-over.

Fruit / Cucumbers

- As soon as bubbles begin to rise evenly in the jars, reduce the temperature to the lowest setting. Then, leave the jars in the warm oven for an additional 25-30 minutes.

Vegetables

- Reduce the temperature to 210°F (100°C) as soon as bubbles begin to rise evenly in the jars.
- After the canning time has finished, reduce the temperature to the lowest setting and leave the jars in the oven for an additional 25-30 minutes.

After canning



Danger of burns!



Use pot holders when removing the jars from the oven.





- Take the jars out of the oven.
- Cover the jars with a towel and leave to set for approx. 24 hours.
- Make sure all jars are closed properly when storing them.

Dehydrate

Dehydrating is a traditional method of preserving fruit, certain vegetables and herbs.

It is important that fruit and vegetables are ripe and not bruised before they are dehydrated.

- Prepare the food for dehydrating.
 - Peel and core apples, and cut into slices 1/4" (.5 cm) thick.
 - Core plums if necessary.
 - Peel, core and cut pears into wedges.
 - Peel and slice bananas.
 - Clean mushrooms, then either halve or slice them.
 - Remove parsley and dill from the stem.
- Distribute the food evenly over the roasting pan.
- Select Convection Bake  or Surround .
- Select a temperature of 175-200°F (80-100°C).
- Place the roasting pan on shelf level 3.
When using Convection Bake  you can dehydrate on levels 1+3 at the same time.

Food		⌚ [min]
Fruit		120-480
Vegetables		180-480
Herbs		50-60

- Function / ⌚ Drying time
- Convection Bake / Surround

- Reduce the temperature if condensation begins to form in the oven.

 **Danger of burning!**
Use oven gloves when removing the food from the oven.

- Allow the fruit or vegetables to cool down after dehydrating.

Dried fruit must be completely dry, but also soft and elastic. Juice should not escape when cut.

- Store in sealed glass jars or tins.

Tips for pizza, French fries, croquettes and other similar items

Cakes, pies, pizza, baguettes

- Bake frozen pizza on parchment paper placed on the wire oven rack.
- Cook smaller frozen food items on parchment paper placed on a baking tray or the universal tray.
- For smaller frozen food items, use the lowest temperature recommended on the packaging.
- Turn small frozen food items several times during cooking.

Preparation

Handling food carefully will help protect your health.

- Select the oven mode and temperatures recommended on the food's packaging.
- Preheat the oven.
- Place the food in the preheated oven on the shelf level recommended on the packaging.
- Check the food at the end of the shortest time recommended on the packaging.

Gentle Bake

The Gentle Bake  mode is ideal for casseroles and gratins which require a crisp top.



Danger of burns!

Make sure the heating elements are turned off and allowed to cool completely.



Danger of injury! The steam from a steam cleaner could reach electrical components and cause a short circuit.

Do not use a steam cleaner to clean this appliance.

All surfaces can discolor or be damaged if unsuitable cleaning agents are used. The front of the oven, in particular, will be damaged by oven cleaners and descalers.

All surfaces are susceptible to scratches. Scratches on glass surfaces could cause a breakage.

Remove any cleaning agent residues immediately.

Unsuitable cleaning agents

To avoid damaging surfaces when cleaning, do not use:

- Cleaners containing soda, ammonia, acids or chlorides
- Lime removers on the front of the ovens
- Abrasive cleaning agents, such as scouring powder, scouring cream, pumice stones
- Solvent-based cleaners
- Stainless steel cleaners
- Dishwasher cleaners
- Glass cleaners
- Ceramic cooktop cleaners
- Hard, abrasive sponges and brushes, such as pot scrubbers or used sponges that still contain traces of abrasive cleaner
- Eraser sponges
- Sharp metal scrapers
- Steel wool
- Spot cleaners
- Oven cleaners
- Stainless steel scouring pads

If stains and food residues are allowed to remain on surfaces for a longer period of time, it may no longer be possible to remove them. Continued use without cleaning will make the oven much harder to clean.

Remove any soiling immediately.

Cleaning and care

The accessories are not dishwasher-safe.

Tips

- Soiling caused by spilt juices and cake mixtures is best removed while the oven is still warm. Use caution and make sure the oven is not too hot - Danger of burns.
- To make cleaning easier you can dismantle the oven door, remove the side runners and lower the Browning/Broiling element.

Normal soiling

There is a seal around the oven interior which seals the inside of the door.

Take care not to rub, damage or move the gasket.



Do not clean the door gasket - the door gasket is essential for a good seal.

- Remove normal soiling immediately using a clean sponge with warm water and liquid dish soap applied with a clean, damp microfiber cloth.
- After cleaning, ensure that any detergent residue is removed with clean water. This is particularly important when cleaning surfaces treated with PerfectClean enamel as detergent residue can impair the non-stick properties.
- After cleaning, dry the surfaces with a soft cloth.

Stubborn soiling

Do not use a protective coating (i.e. tin foil) to line the oven and do not use commercial oven cleaner unless certified for use in a self-cleaning oven.

Remove coarse soiling from the oven and scrape any burnt-on residues off enameled surfaces with a glass scraper.

Use the Self Clean  program. See “Cleaning the oven interior with Self Clean ” for more information.

Spilled fruit and roasting juices may cause lasting discoloration or matte patches on enameled surfaces. This does not affect the functional characteristics of the finish. Do not attempt to remove these marks. Clean them following the instructions given here.

- Baked on deposits can be removed with a glass scraper or with a non-abrasive steel wool pad, warm water and liquid dish soap.

The cavity does not need to be treated with oven cleaner as it is equipped with a Self Clean  program.

- If necessary, the scouring pad on the back of a non-scratching washing-up sponge can be used to remove the soiling after the holding time.
- After cleaning, remove all oven cleaning agent residues thoroughly with clean water, and then dry the surfaces.

Cleaning and care

Cleaning the oven interior with Self Clean

Instead of cleaning the oven by hand, you can use the Self Clean  program.

Any grime that has accumulated will be broken down and burnt to ash as a result of the high temperatures.

This oven has three Self Clean levels, each with a different duration:

- Level 1 for light soiling
- Level 2 for heavier soiling
- Level 3 for very heavy soiling

Once the Self Clean program has started, the door will lock automatically. It cannot be opened again until the program has ended.

You can also set a delayed start time for the Self Clean program, in order to take advantage of off-peak electricity rates, for example.

At the end of the Self Clean program, any remaining residues (e.g., ash) can be easily wiped away.

Preparing for the Self Clean program

The high temperatures used during Self Clean will damage accessories that are not designed for cleaning in the Self Clean program.

Please remove these accessories from the oven before starting the Self Clean program. This also applies to accessories purchased separately.

The following accessories are suitable for cleaning in the Self Clean program and can remain in the oven:

- Shelf runners
- FlexiClips with wire rack HFCBBR 30-2
- Wire oven rack HBBR 30-2
- Take all accessories out of the oven that are not “Self Clean safe” out of the oven.
- Place the wire oven rack on the top shelf level.

If not removed, coarse soiling can smoke and cause the Self Clean program to turn itself off.

- Remove any coarse soiling before running the Self Clean program.

Starting the Self Clean program



Risk of burns!

When Self Cleaning the front of the oven becomes hotter than with normal oven use.

Prevent children from touching the oven during Self Clean.

- Select Self Clean

PY 1 appears in the display. The number flashes.

Use the rotary selector to select between *PY 1*, *PY 2* or *PY 3*.

- Select the level required.
- Confirm with OK.

The Self Clean program will now start.

will appear in the display.

will flash until the door is locked.

The oven heating and the cooling fan will then turn on automatically.

The oven light will not turn on during the Self Clean program.

To see how the Self Clean program is progressing, highlight in the display.

- Select “Settings”.
- If necessary, use the rotary selector to move the symbol until it appears under .





The time remaining for the Self Clean program will appear in the display. The duration cannot be altered.

If you have set a timer you will hear a signal, will flash and the time will count down. Once you press OK, the audible and visual signals will turn off. *PY* and the number of the Self Clean level chosen will reappear.

Cleaning and care



Delaying the start time of the Self Clean program



Start the Self Clean program as described above and then set the required finish time within the first five minutes of starting the program.

- Select .
- Use the rotary selector   to move the triangle  until it appears under .

 appears.

- Confirm with *OK*.

When you turn the rotary selector   clockwise, the finish time will appear in the display. This is calculated from the actual time of day plus the duration of your selected Self Clean program.

- Use the rotary selector   to select the required finish time.
- Confirm with *OK*.

The finish time is now saved.

The oven heating switches off.



The finish time can be changed at any time up until the start time for the program.

As soon as the start time is reached, the oven heating and the cooling fan will switch on. The duration will appear in the display.



At the end of the Self Clean program



0:00,  and  will appear in the display.

The door is locked as long as the  symbol is lit up. The  symbol will start flashing as soon as the door lock has been deactivated.

When the door lock has been deactivated:

-  goes out,
-  flashes, and
- short beeps will sound if the buzzer tone is activated (see “Settings”).

- Turn the mode selector to .

Acoustic and visual signals are turned off.

Danger of burns!

Danger of burns! Wait until the oven has cooled down before removing any residual soiling left in the oven compartment from the Self Clean program.

- Wipe any residues (e.g.ash) left behind after the Self Clean program out of the oven compartment and off of any accessories. The amount of ash will vary depending on how dirty the oven was.



Most soiling can be easily removed using a clean, soft sponge and a mild solution of warm water and liquid dish soap.

Depending on the degree of soiling before cleaning, there may be a visible layer of soiling across the inner glass pane on the door. This should be removed using the scouring side of a dish sponge or with a stainless steel spiral sponge and liquid dish soap.

Please note:

- There is a fiberglas seal around the oven interior which seals the inside of the door. Take care not to rub, damage or move the gasket. Do not clean the door gasket - the door gasket is essential for a good seal.
- Spilt fruit juices may cause lasting discoloration to enameled surfaces. This discoloration is permanent but will not affect the efficiency of the enamel. Do not attempt to remove these marks.

The Self Clean program is canceled

If the Self Clean program is canceled, the oven door will remain locked until the temperature inside the oven drops to below 535°F (280°C). The  symbol will light up until the temperature has dropped below this level. The door can be opened as soon as the  symbol starts flashing.

The following will cause the Self Clean program to cancel:

- Turn the mode selector to •.

Once the door has been unlocked,  will go out and the time of day will reappear in the display. If necessary, start the Self Clean program again.

- Turning the mode selector to a different mode.

Py and  appear in the display.

Once the door has been unlocked,  will go out and *Py* will flash.

- A power failure.

Py and  appear in the display.

Once the door has been unlocked,  will go out and *Py* will flash.

When the power is restored *Py* will light in the display until the temperature has dropped below 535°F (280°C).  then appears in the display. The door is unlocked and the time of day is displayed.

Cleaning and care

Door removal

The door weighs approx. 36 lbs (16 kg).

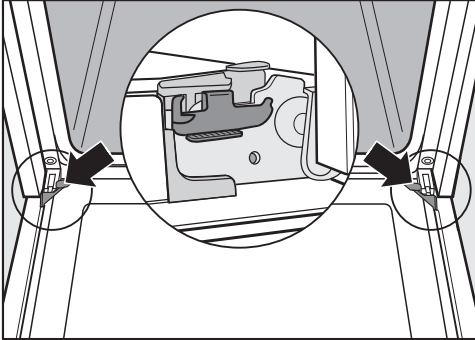

The oven door is connected to the hinges by retainers. Before removing the door from the retainers, the locking clamps on both hinges have to be released.

- Open the door fully.

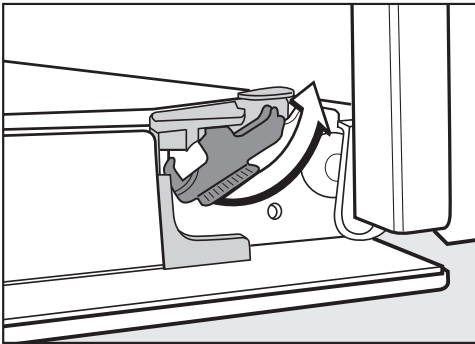

- Release the locking clamps by turning them as far as they will go.

Do not pull the door horizontally off its retainers, as they will spring back against the oven.

Do not pull the door off the retainers by the handle, as the handle could break off.

- Raise the door up till it rests partially open.



- Hold the door on either side and pull it diagonally upwards from the hinge guides. Make sure that you lift the door off straight.

Reinstalling the door

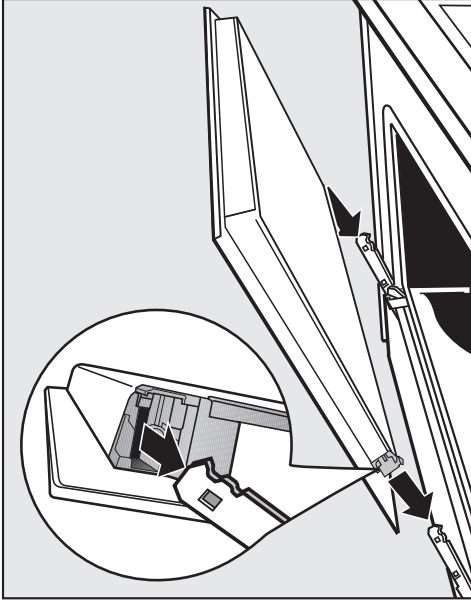

- Hold both sides of the door securely and carefully fit it onto the brackets of the hinges. Make sure that the door goes on straight.

- Open the door fully.

If the locking clamps are not locked, the door can easily become detached from the brackets and be damaged.

You must make sure that the locking clamps are locked again.

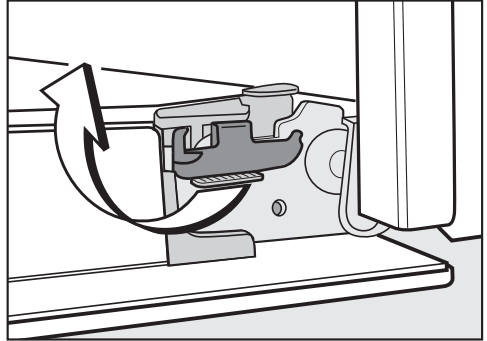

- To relock the locking clamps, turn them back up to the horizontal position as far as they will go.

Cleaning and care

Removing the shelf runners

 **Danger of injury!**
Do not use the oven without the shelf runners correctly inserted.

 **Danger of burns!** Make sure the heating elements are turned off and that the oven cavity is cool.

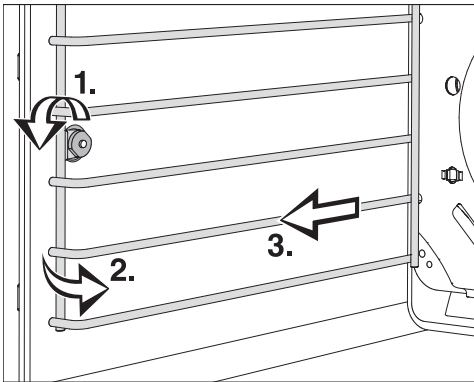

- Loosen the screw (1.).
- Pull the runners out of the holder (2.) at the front of the oven, and then pull them out of the oven (3.).



The runners can be **reinstalled** in the reverse order.

- Be sure that all parts are installed correctly.

Frequently asked questions

The following faults can be corrected without contacting the Miele Service Department. If in doubt, please contact Miele.

 **Danger of injury!** Repairs should only be carried out by a qualified and trained professional in accordance with local and national safety regulations. Unauthorized repairs could cause personal injury or machine damage.

Problem	Possible cause and solution
<p>This display is dark.</p>	<p>The time of day display is deactivated, so when the appliance is turned off, the time of day display is turned off.</p> <ul style="list-style-type: none"> ■ As soon as the oven is turned on, the time of day will appear. If you want it to be displayed continuously, the setting to turn the time of day display back on must be changed (see “Settings – P I”).
	<p>There is no power to the appliance.</p> <ul style="list-style-type: none"> ■ Check if the circuit breaker has tripped.
<p>An oven mode has been selected and the time of day and the  symbol still appear in the display.</p>	<p>The system lock  is On.</p> <ul style="list-style-type: none"> ■ Turn off the system lock (see “System lock ”).

Frequently asked questions

Problem	Possible cause and solution
<p>The oven does not heat up.</p>	<p>Demo mode has been activated. <i>DE5_</i> appears in the display. The oven can be operated but does not heat up.</p> <ul style="list-style-type: none"> ■ Deactivate Demo mode (see “Settings – <i>P 10</i>”).
<p>An oven mode has been selected but the oven is not working.</p>	<p>There has been a power failure which has caused the current cooking process to stop.</p> <ul style="list-style-type: none"> ■ Turn the mode selector to the ● position and turn the oven off. Start the cooking process again.
<p>12:00 will appear in the display with ▲ flashing under ☺:</p>	<p>The power supply was interrupted for longer than 200 hours.</p> <ul style="list-style-type: none"> ■ Reset the time of day (see “Before using for the first time”).
<p>0:00 appears unexpectedly in this display and the ☺ symbol flashes at the same time. The buzzer may also be sounding.</p>	<p>The oven has been operating for an unusually long period of time, this has activated the “Safety cut-out feature”.</p> <ul style="list-style-type: none"> ■ Turn the mode selector to ●. The oven is now ready to use again immediately.
<p>F 32 appears in the display.</p>	<p>The Self Clean program door lock is not locking.</p> <ul style="list-style-type: none"> ■ Turn the mode selector to the Self Clean program ● again. If the problem persists, contact Miele Technical Service.
<p>F 33 appears in the display.</p>	<p>The door lock for the Self Clean program will not deactivate.</p> <ul style="list-style-type: none"> ■ Turn the mode selector to the ● position and turn the oven off. If the problem persists, contact Miele Technical Service.
<p>F XX appears in the display.</p>	<p>A fault has occurred that you cannot resolve.</p> <ul style="list-style-type: none"> ■ Contact Miele Technical Service.
<p>A noise is heard after the cooking process is complete.</p>	<p>After the cooking process the cooling fan will continue to run for a while after a program is complete to prevent moisture from building up in the oven, on the control panel or surrounding cabinetry. The cooling fan will turn off automatically.</p>

Frequently asked questions

Problem	Possible cause and solution
The oven has turned itself off.	<p>The oven turns off automatically if a button is not pressed after a certain amount of time or after a cooking program has ended to save power.</p> <ul style="list-style-type: none"> ■ Turn the oven back on.
Baked goods are not cooked properly after following the times given in the chart.	<p>A different temperature than that given in the recipe was used.</p> <ul style="list-style-type: none"> ■ Select the temperature required for the recipe.
	<p>The ingredient quantities are different from those given in the recipe.</p> <ul style="list-style-type: none"> ■ Double check the recipe. The addition of more liquid or more eggs will make a wetter mixture which will take longer to cook.
The browning is uneven.	<p>The wrong temperature or shelf level was selected.</p> <ul style="list-style-type: none"> ■ There will always be a slight unevenness. If the unevenness is great, check whether the correct temperature and shelf level were selected.
	<p>The material or color of the bakeware is not suitable for the oven mode selected.</p> <ul style="list-style-type: none"> ■ When using Surround  use matte, dark colored pans. Light colored, shiny pans will not produce as desirable results.
The oven lighting turns off after a short time.	<p>The oven is factory set to turn off automatically after 15 seconds. This setting can be changed (see “Settings”).</p>

Frequently asked questions

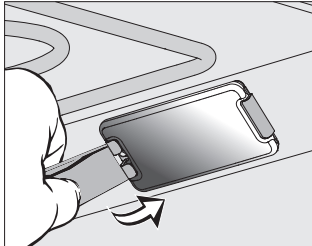
Problem	Possible cause and solution
<p data-bbox="73 201 365 256">The oven lighting does not turn on.</p> 	<p data-bbox="398 201 874 229">The halogen bulb needs to be replaced.</p> <div data-bbox="404 236 1043 363" style="border: 1px solid gray; padding: 5px;"> <p data-bbox="415 244 667 280">⚠ Danger of burns!</p> <p data-bbox="415 288 1020 347">Make sure the heating elements are turned off and allowed to cool completely.</p> </div> <div data-bbox="404 379 1043 531" style="border: 1px solid gray; padding: 5px;"> <p data-bbox="415 387 925 416">The lamp cover may be damaged if it falls.</p> <p data-bbox="415 424 1001 515">When removing the cover hold it firmly so that it does not fall. Place a towel on the oven floor and open door to avoid damage.</p> </div> <ul data-bbox="398 547 1037 879" style="list-style-type: none"> <li data-bbox="398 547 1014 576">■ Disconnect the appliance from the power supply. <li data-bbox="398 584 1037 643">■ Loosen the bulb cover with the tool supplied at the back of the frame. <li data-bbox="398 651 1009 742">■ Do not touch the halogen bulb with bare fingers. Observe the manufacturer's instructions. Remove the halogen bulb. <li data-bbox="398 750 964 809">■ Replace it with a new halogen bulb (Sylvania 66740, 120 V, 40 W, G9, FS1). <li data-bbox="398 817 871 845">■ Press the bulb cover back into place. <li data-bbox="398 853 953 879">■ Reconnect the oven to the electrical supply.
<p data-bbox="73 895 381 986">There is soiling in the oven after the Self Clean program.</p>	<p data-bbox="398 895 1020 954">The Self Clean program burns off soiling in the oven and leaves it as ash.</p> <ul data-bbox="398 962 1009 1086" style="list-style-type: none"> <li data-bbox="398 962 1009 1021">■ Using a soft sponge, warm water and liquid dish soap remove the ashes. <p data-bbox="426 1029 964 1086">If coarse soiling remains, start the Self Clean program again with a longer duration.</p>
<p data-bbox="73 1102 353 1161">The oven door cannot be closed.</p>	<p data-bbox="398 1102 986 1257">As soon as the inner pane is damaged, a safety mechanism blocks the oven door. The oven door cannot be closed and the oven functions (oven modes, special modes and self clean) cannot be used.</p> <ul data-bbox="398 1265 893 1291" style="list-style-type: none"> <li data-bbox="398 1265 893 1291">■ Contact the Miele Service Department.

Frequently asked questions

Problem	Possible cause and solution
The rack and other accessories make a noise when being pushed into or pulled out of the oven.	<p>The heat resistant surface of the shelf runners creates friction when accessories are taken in and out of the oven.</p> <ul style="list-style-type: none">■ To reduce the friction, lubricate the runners with a few drops of cooking oil applied with a paper towel. Repeat this process after each Self Clean program.

Technical Service

After sales service

In the event of a fault which you cannot easily correct yourself, please contact:

- your Miele dealer, or
- the Miele Technical Service Department.

See back cover for contact details.

Please quote the model and serial number of your appliance when contacting Miele.

This information is given on the data plate, visible on the front frame of the oven, with the door fully open.

Warranty

For further information, please refer to your warranty booklet.

Disposal of the packing material

The cardboard box and packing materials protect the appliance during shipping. They have been designed to be biodegradable and recyclable.

Ensure that any plastic wrappings, bags, etc. are disposed of safely and kept out of the reach of children.
Danger of suffocation!

Disposal of your old appliance

Electrical and electronic appliances contain valuable materials. They also contain certain substances, compounds and components which were essential for the proper functioning and safe use of the equipment. Handling these materials improperly by disposing of them in your household waste can be harmful to your health and the environment. Therefore, please do not dispose of your old appliance with regular household waste and follow local regulations on proper disposal.



Consult with local authorities, dealers or Miele in order to dispose of and recycle electrical and electronic appliances. Miele assumes no responsibility for deleting any personal data left on the appliance being disposed. Please ensure that your old appliance is kept away from children until removal. Observe safety requirements for appliances that may tip over or pose an entrapment hazard.

Electrical connection

CAUTION:

Before servicing, disconnect the power supply by either removing the fuse, shutting off the power main or manually “tripping” the circuit breaker.

Installation, repair and maintenance should be performed by a Miele authorized service technician. Work by unqualified persons could be dangerous and may void the warranty.

Before connecting the appliance to the power supply, make sure that the voltage and frequency listed on the data plate correspond with the household electrical supply. This data must correspond to prevent machine damage. Consult an electrician if in doubt.

Only operate the appliance after it has been installed into cabinetry.

The plug must be inserted into a suitable outlet that has been installed and grounded in compliance with all applicable local regulations.

WARNING: THIS APPLIANCE MUST BE GROUNDED

Installer: Please pass these instructions on to the customer.

Electrical connection

The oven is equipped with a power cord approx. 5' 6" (1.7 m) in length with a NEMA 14-30 P plug ready for connection to the power supply:

- 120/208 V, 30 A, 60 Hz
- or
- 120/240 V, 30 A, 60 Hz

The voltage can be adjusted (see “Settings - P 9”).

SAVE THESE INSTRUCTIONS FOR THE ELECTRICAL INSPECTOR'S USE.

Appliance and cut-out dimensions

Miele ovens can be installed flush or proud. Discuss your installation requirements with your architect, designer and installer.

Undercounter installation

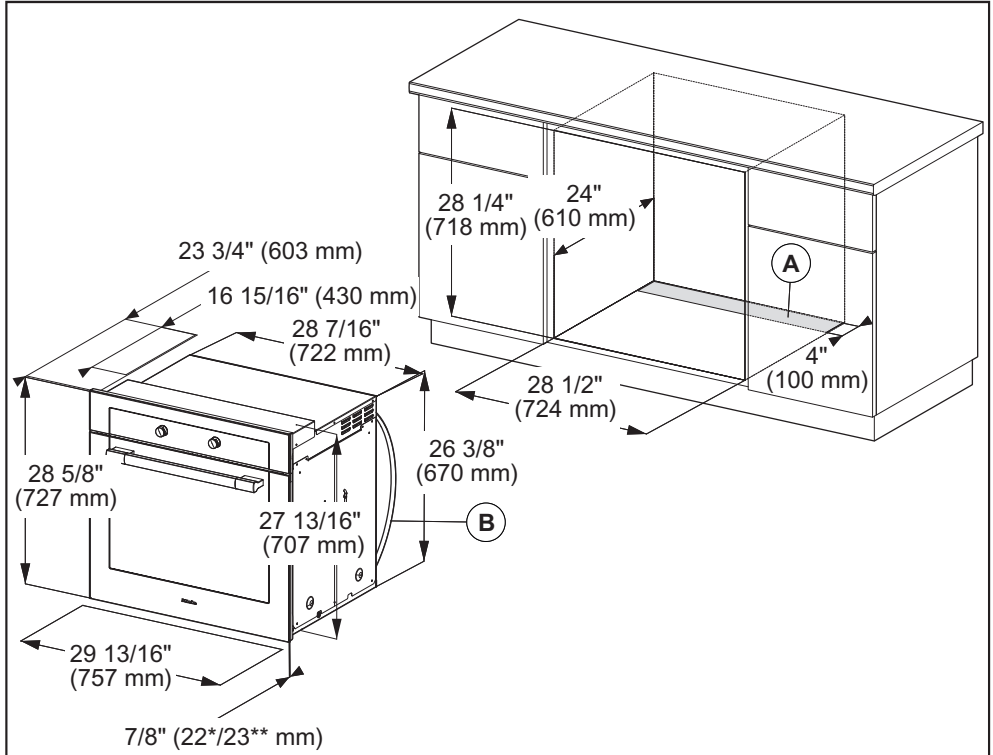

Ⓐ Cut-out (4" x 28 3/8" / 100 mm x 720 mm) in the bottom of the cabinet for power cord and ventilation

Ⓑ Power cord with plug

* Oven with glass front

** Oven with metal front

Depending on the model, the oven front may differ from the one shown the drawing. Current specifications can be found on the Miele website.

Installation diagrams

Installation into a tall cabinet

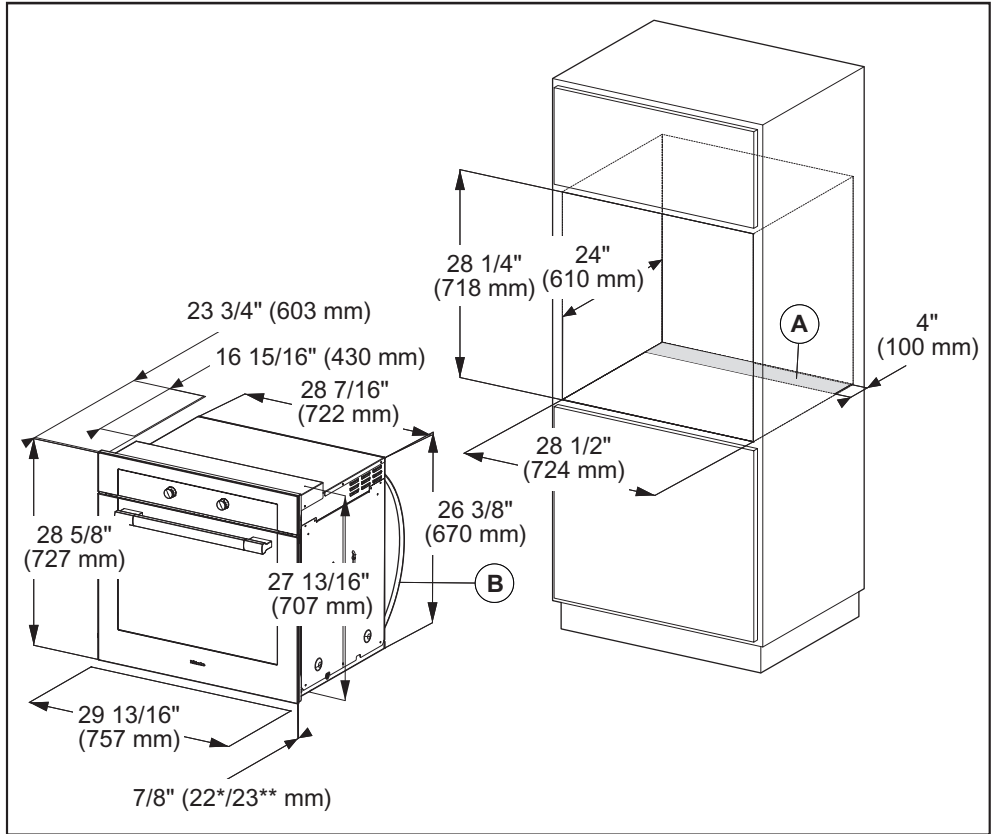

- Ⓐ Cut-out (4" x 28 3/8" / 100 mm x 720 mm) in the bottom of the cabinet for power cord and ventilation
 - Ⓑ Power cord with plug
- * Oven with glass front
** Oven with metal front

Depending on the model, the oven front may differ from the one shown the drawing. Current specifications can be found on the Miele website.

Installing the oven

 The oven must not be operated until it has been properly installed within cabinetry.

The oven must have an adequate supply of cool air for proper operation. The required air must not be heated excessively by other heat sources, e.g. wood burning stove.

Observe the following when installing:

Build into cabinetry with no back wall.

Make sure that the shelf that the oven sits on does not touch the wall. Do not install insulation strips on the side walls of the cabinet housing.

Before installation

- Before connecting the oven to the power supply, first disconnect the power supply from the oven isolator switch.

Installing the oven

- Connect the power cord to the electrical supply.

Do not carry the oven by the door handle. The door can be damaged. Use the handles on each side of the oven to carry it.

It is recommended that you remove the door before installing the appliance (see “Cleaning and Care - Removing the door”) and all oven accessories from the cavity. This will make for easier installation into the niche and will not tempt you to use the handle to carry it.

- Remove the side handles, if any.
- Push the oven into the cabinetry and align it.
- Open the door (if it was not removed previously).

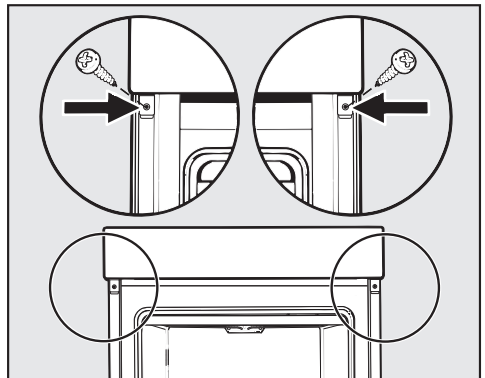

- Use the supplied screws to secure the oven to the side walls of the cabinetry through the holes in the trim.
- Reinstall the door, if necessary (see “Cleaning and care - Installing the door”).

**Please have the model and serial number
of your appliance available when
contacting Customer Service.**

U.S.A.

Miele, Inc.

National Headquarters

9 Independence Way
Princeton, NJ 08540

Customer Service & Support

Phone: 888-99-MIELE(64353)
info@mieleusa.com
www.mieleusa.com

International Headquarters

Miele & Cie. KG
Carl-Miele-Straße 29
33332 Gütersloh
Germany

Canada

**Importer
Miele Limited**

Headquarters and Miele Centre

161 Four Valley Drive
Vaughan, ON L4K 4V8
www.miele.ca

Customer Care Centre

Phone: 800-565-6435
905-532-2272
customercare@miele.ca

H6180BP; H6280BP

en-US, CA

M.-Nr. 09 786 760 / 09